



Kit #

10015188

10015168

10015113

2686 Highway 92—Oskaloosa, IA 52577

Phone: 800.334.6150

www.kelderman.com

**2023+ Ford F250-350-450
Pickup Stock Height Rear
Install Instructions**



INTRODUCTION

IMPORTANT!

It is important that the entire installation instructions be read thoroughly before proceeding with suspension installation.

PRODUCT INSTALLER RESPONSIBILITIES

Installer is responsible for installing the product in accordance with Kelderman Mfg., Inc. specifications and installation instructions.

Installer is responsible for providing proper installation of vehicle components and attachments as well as required or necessary clearance for suspension components, axles, wheels, tires, and other vehicle components to ensure a safe and sound installation and operations.

Installer is responsible for advising the owner of proper use, service, and maintenance required by the product and for supplying maintenance and other instruction as readily available from Kelderman Mfg., Inc.

WARNING!

A correct installation must result in the suspension and axle being “loaded” within the range specified by axle and suspension manufacturers. Please check vehicle specifications and intended usage to insure axle will be within Gross Weight Rating (GAWR). No alteration of any suspension component is permitted.

DEFINITION OF TERMS

WARNING –indicates a potentially hazardous situation which, if not avoided, could result in death or serious injury.

CAUTION –a potential hazardous situation may result in property damage.

NOTE –provide information or suggestions that help you correctly perform a task.

TORQUE –the italicized torque alerts you to tighten fasteners to a specified torque value.

PRE-INSTALLATION CHECKLIST

- Check the vehicle wheel alignment prior to installation to ensure no precondition already exists; record the information for verification.
- Measure and record the wheelbase and centering dimensions before beginning installation.
- Measure and record the height from the ground up to the rear of the frame.
- Measure and record the pinion angle. *See page 5 for specific instructions.*
- Remove the attached body, if applicable. Remember to disconnect all electrical connections and fuel filler tube, before removing the body. The installation can also be completed using a lift to raise the vehicle. If using a lift, chassis body removal may not be necessary but removal of rear wheels will aid in installation.
- If not using a lift, block the front wheels so the vehicle cannot roll.
- Jack up the rear frame of the truck in order to unload the rear leaf springs. Do not lift the wheels off the ground (if not using a lift to install the suspension). Do not jack on the axle itself.

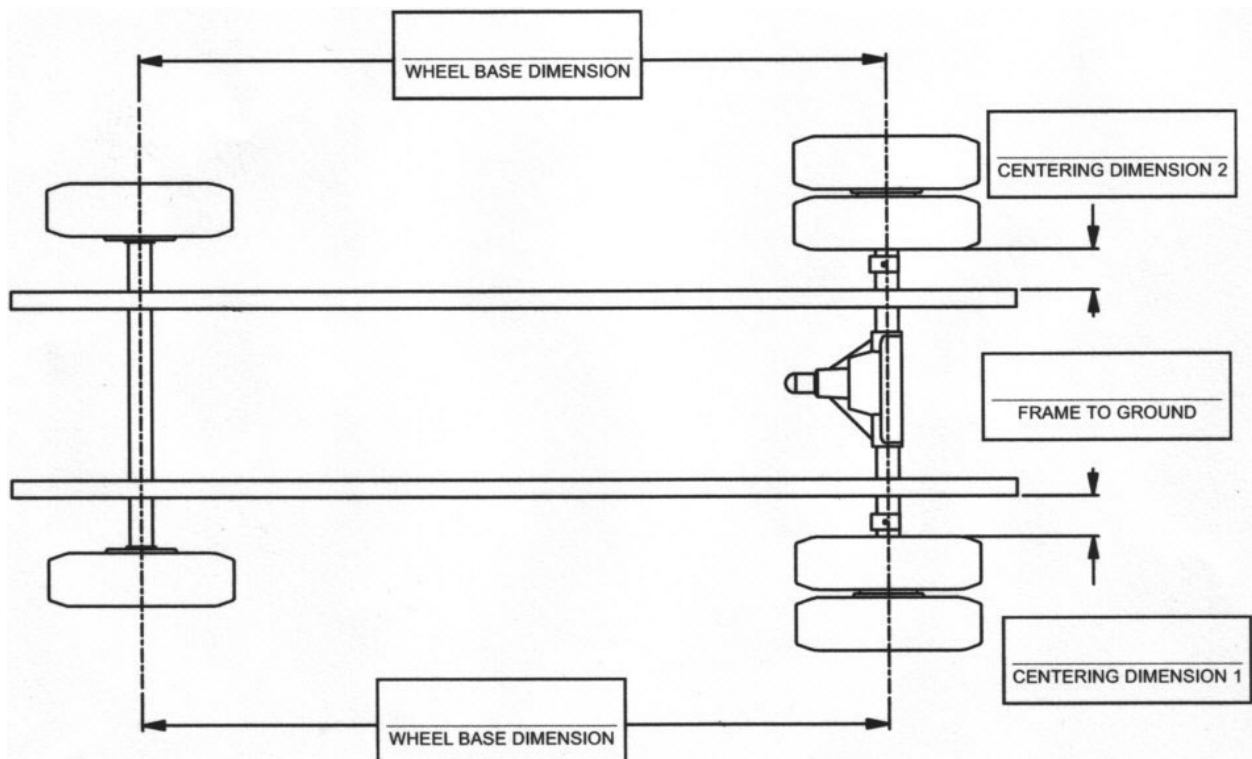

DETERMINING PINION ANGLE

The pinion angle is critical in the correct installation of your Kelderman Air Suspension System. The pinion angle can be easily determined with the use of a magnetic angle gauge.

To measure the angle, find a flat surface to attach angle gauge. Mark the location of your gauge with a marking pen or scribe. Record the angle on the gauge for future reference.

Note: It may be necessary to remove gauge.
Marking the position of the gauge is critical to ensure accurate angle readings during adjustment steps of the assembly of your Kelderman Air Suspension System.



Pinion Angle: _____ °

Pinion Angle: _____ °

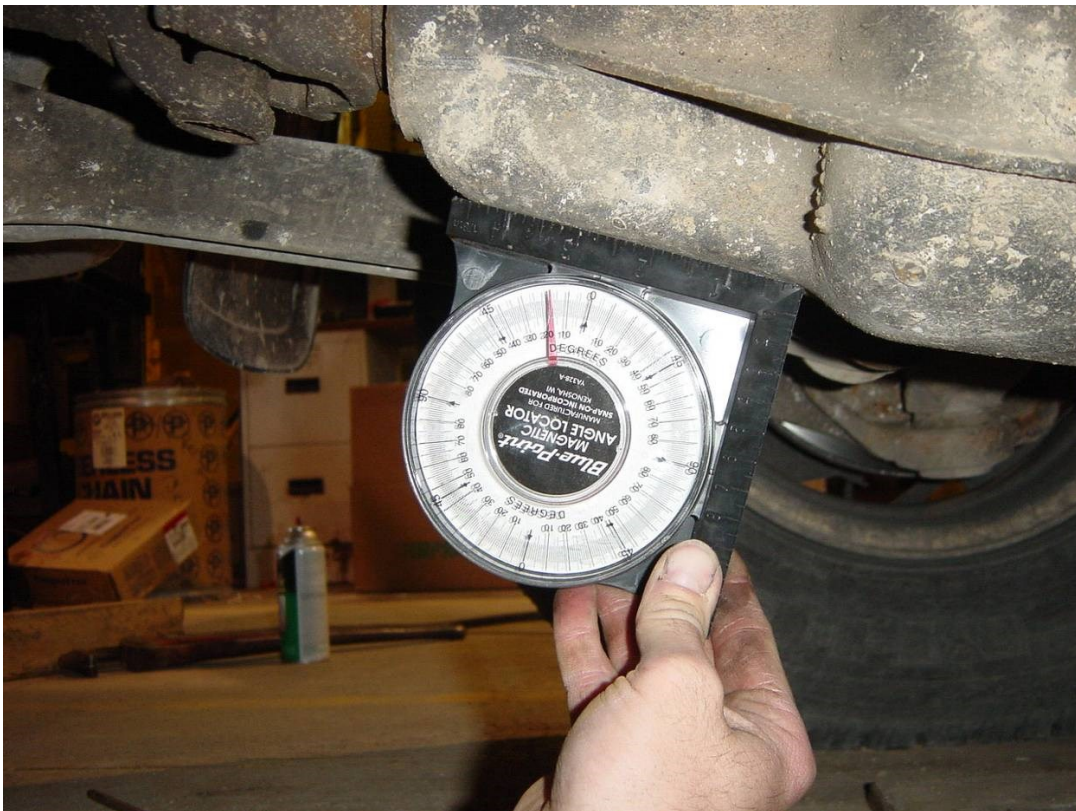

Kit Disassembly

1) Before disassembling any components, measure the pinion angle and record the angle in the space provided on page 5. This is important as you will need to put the axle back to this measurement at the completion of installation.

NOTE: WHEN WELDING USE AN ANTI SURGE PROTECTOR OR UNHOOK THE BATTERIES TO REDUCE THE CHANCE OF DAMAGING THE TRUCK'S ELECTRONICS.



2) Jack the rear of the frame so that the tension is off of the leaf springs. Place a set of jack stands under the frame, block the tires so that they will not move, and place a jack stand under the pinion so it does not rotate. Remove the skid plate & emergency brake line bracket.



If truck comes equipped with a factory sway bar then the bolts will need to be removed and let the sway bar hang from the end links.

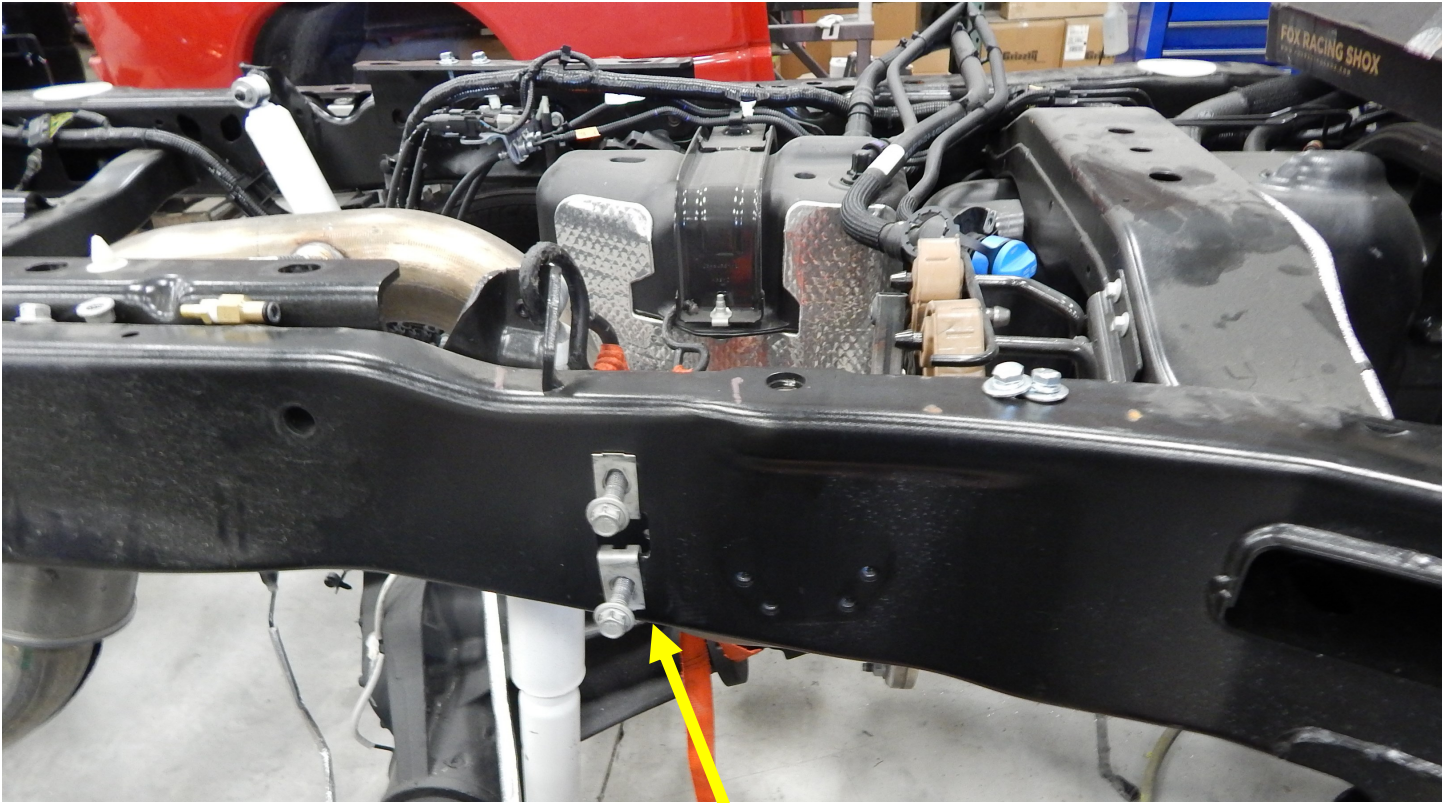

Passenger side pictured. This truck is equipped with factory sway bar

Remove blocks, axle clamps and factory bolts on the axle after removing leaf springs. Both axles should look as pictured before install process. Keep factory leaf spring bolts for kit install.

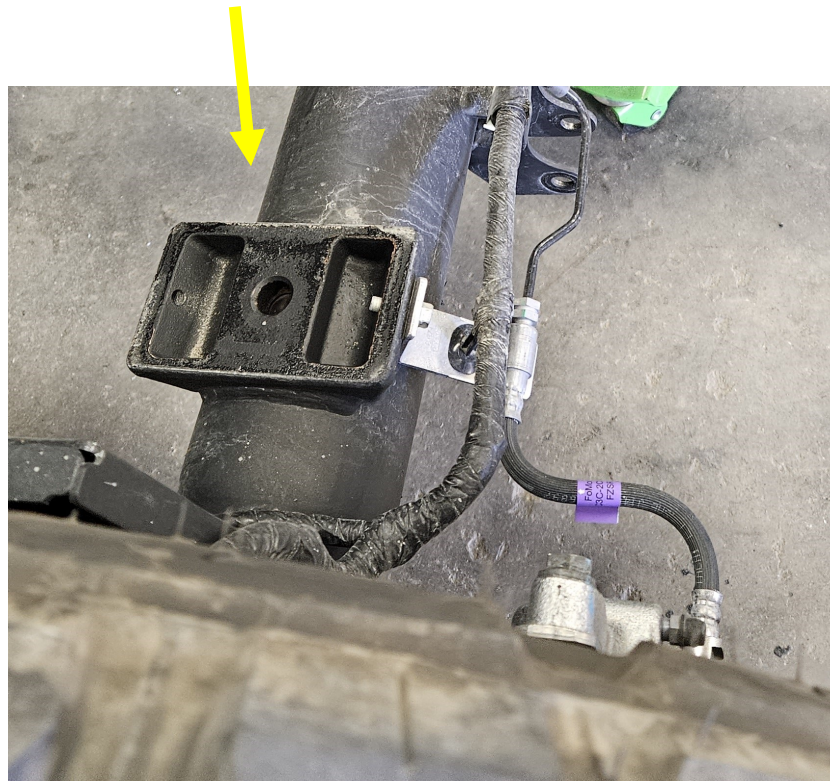

Kit Assembly

1) Locate the Trailing Arm Mounts (Part # 69034). They fasten to the factory leaf spring perch with the original leaf spring bolts. You will also drill (2) holes on each side for the 1/2" x 1-1/2" bolts that fastens into the bottom of the frame and the perch mounting tab weldment. It may require some grinding on the bottom edge of the frame where it is stamped to allow the trailing arm mount to sit flush. You will also need to weld on the front side of the bracket. Welding the bracket will keep the bracket from creating any popping noises under acceleration and deceleration. Torque the 1/2" bolt to 85 ft./lbs. and the factory bolt to 225 ft./lbs.

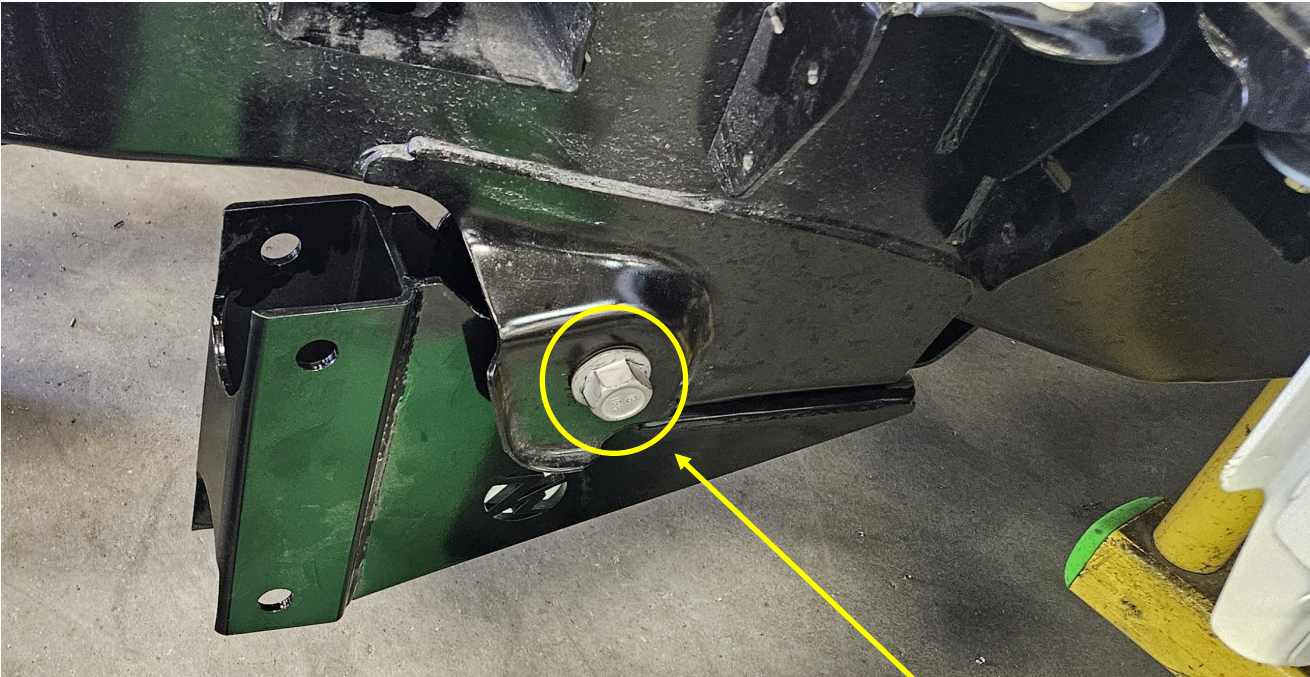

Factory Leaf Spring Bolt

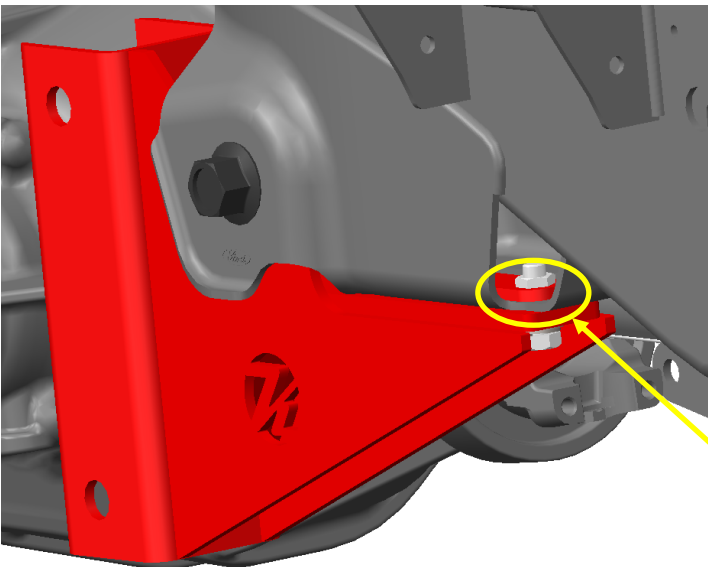

Weld front of tab weldment after installing hardware in location shown.



Grind off bottom of frame before welding

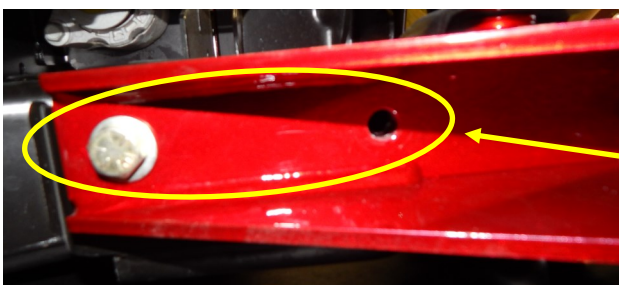

Drill holes in frame for 1/2" bolts.

**Recommended to drill holes in progression 13/64" then 17/64" then 3/8" then 17/32"*

2) Locate the End Link Brackets (#69335-DS & 69338-PS) and End Links (#69529). They attach to the frame with the factory sway bar mount hardware and 1/2"-20 x 3" bolts. Sway bar will attach to the end links later in the install.

Factory Sway Bar Hardware

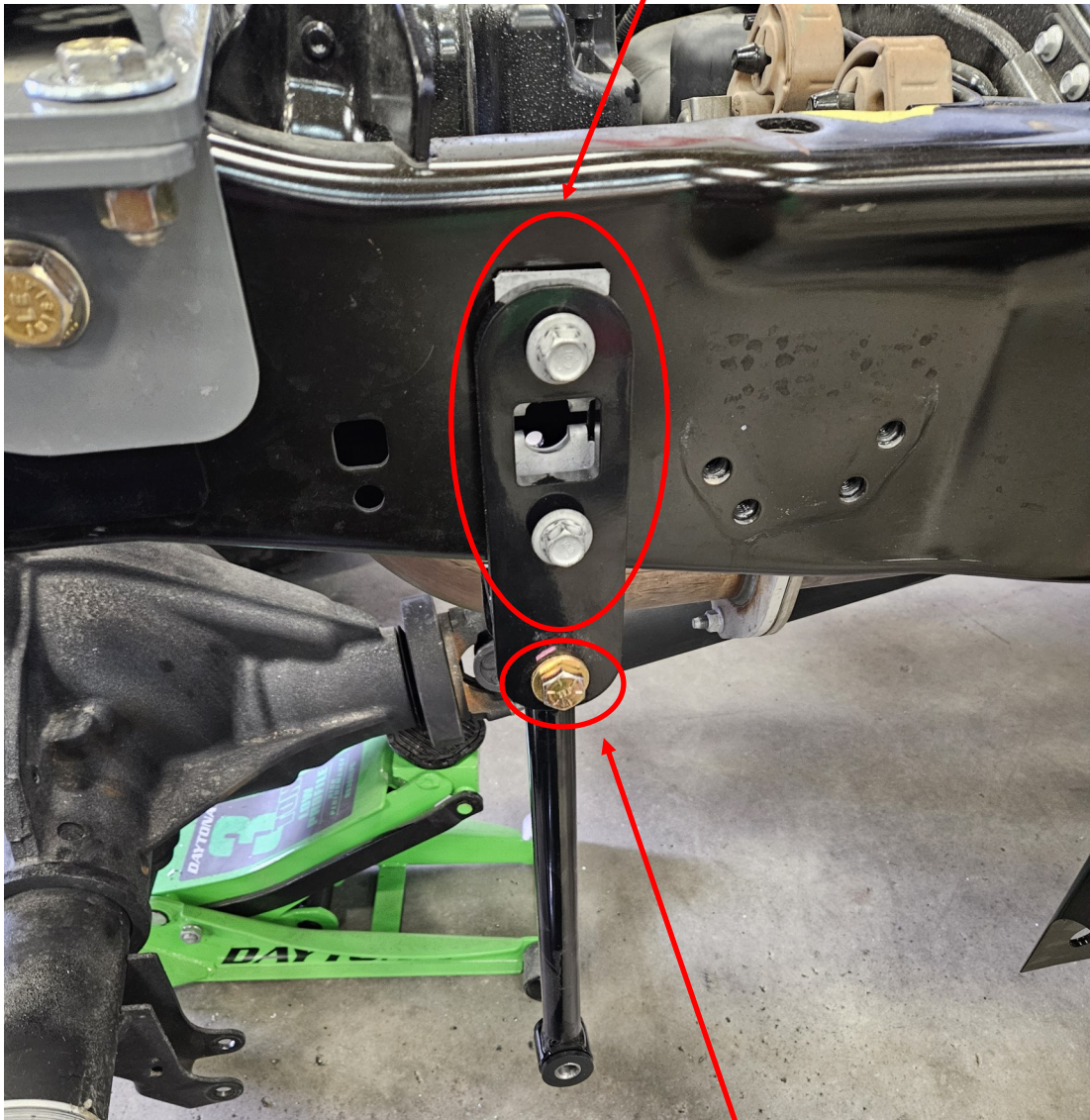

1/2"-20 3" Bolts

3) Locate the Upper Bag Mounts (#69048-DS/10015124-PS). Install 10mm Wingnut Tabs (#69528) with M10-1.5 x 25mm bolts. Leave loose. Insert wingnut tabs into slots underneath the frame. Leave loose and measure from the rear crossmember to the passenger side upper bag mount. Run tape measure on the drivers side and set the divers side upper bag mount to measured distance on passenger side. Torque the M10 bolts to 45 ft./lbs. The passenger side is a weldment that includes the upper Panhard Bar Mount.

NOTE: ON PASSENGER SIDE, YOU WILL HAVE TO REMOVE THE CLIP THAT HOLDS THE EXHAUST SENSOR WIRE. MAKE SURE TO ZIP TIE THE WIRING AWAY FROM THE EXHAUST SO IT DOES NOT DAMAGE THE WIRING HARNESS.

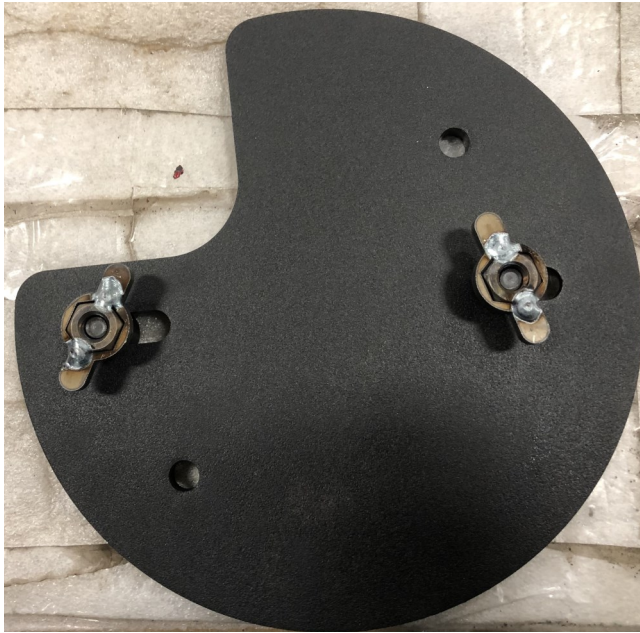

Passenger Side shown with 10mm Wingnut Tabs



Drivers Side shown with M10 bolts installed.



Measurement should be around 17-1/2"



4) Locate the Side Plates (#10015123). Fasten to the side of the frame with factory bolts and 5/8"-18 x 4" & 4-1/2" bolts. Torque the 5/8" bolts to 150 ft./lbs.

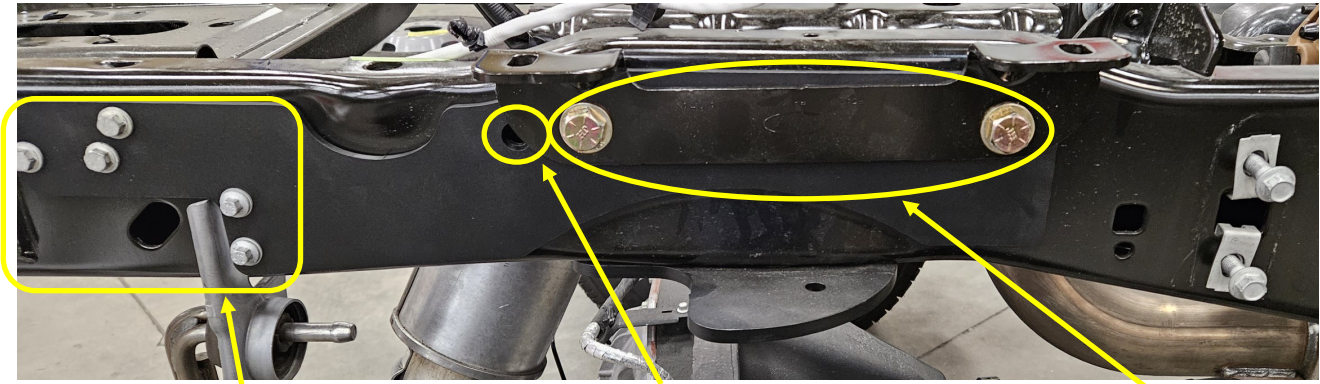

Re-use factory hardware

If using a 5th Wheel Hitch, you won't use the 5/8"-18 x 4" bolt.

5/8"-18 x 4-1/2" bolt.

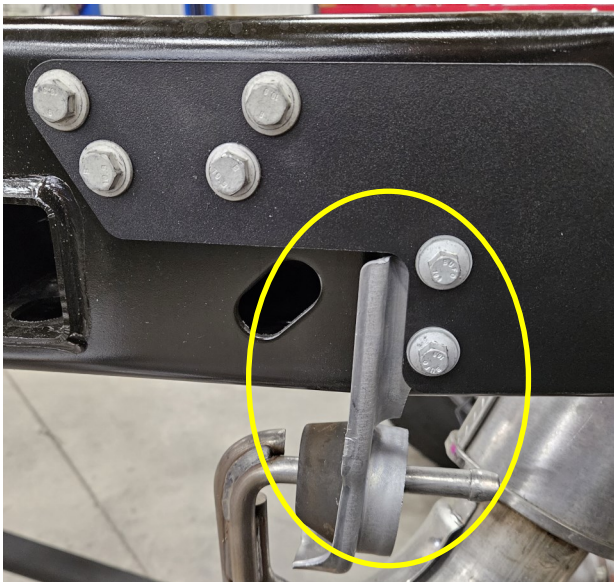

Make sure to place the exhaust hanger mount is in between the frame and the side plate.



The passenger side upper air bag mount is also the upper pan hard bar mount. It fastens to the side of the frame with the 5/8" x 4"-1/2 bolts. Torque the 5/8" bolt to 155 ft./lbs.



If truck comes with factory or Aftermarket 5th wheel hitch, you will mount the (2) side plates on the outside of the frame side plates.

5) Locate the Lower Bag Mounts, Air Bags (#80012-5748) and the Lower Axle Clamps. The lower air bag will mount to the axle on top of the leaf spring perch. Fasten to the axle clamp with the 5/8"-18 x 8" (3.5 & 4.0" Axle) or 5/8"-18 x 8-1/2" (4.5" Axle) bolts. Air Bag fastens to lower bag mount with 3/4"-10 jam nut.

BEFORE MOUNTING THE LOWER AIR BAG MOUNT ON THE PASSENGER SIDE, MAKE SURE TO MOVE THE A.B.S. LINE OUT OF THE FACTORY LOCATION. FAILURE TO DO SO WILL CAUSE THE LINE TO BE DAMAGED.

Axle Size	Lower Bag Mount #	Axle Clamp #
3.5" Axle	DS—69061	69087
	PS—69062	
4.0 Axle	DS—69250	69085
	PS—10015184	
4.5 Axle	DS—69161	69082
	PS—69162	

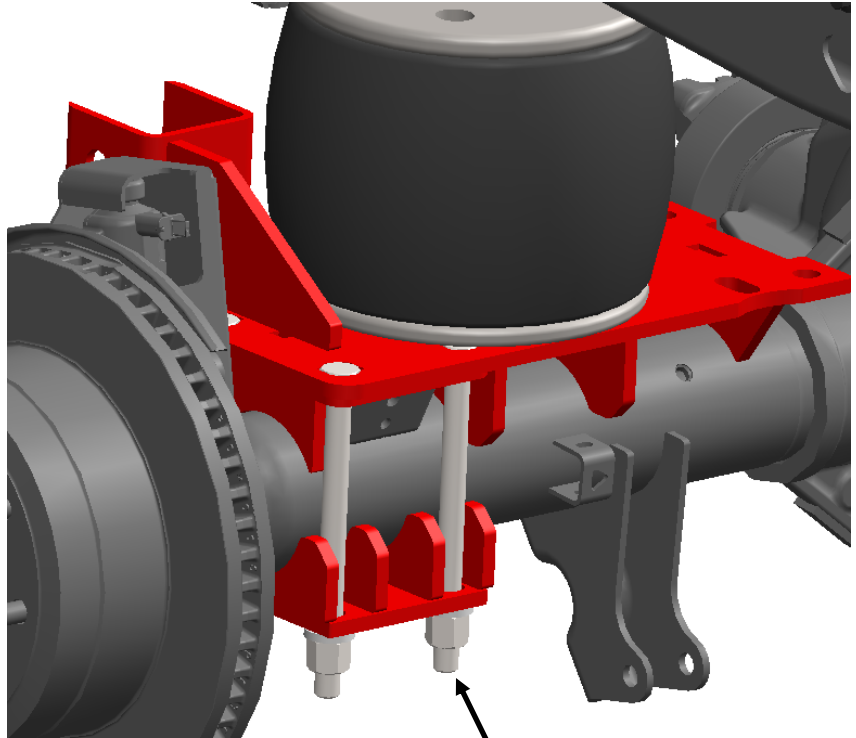
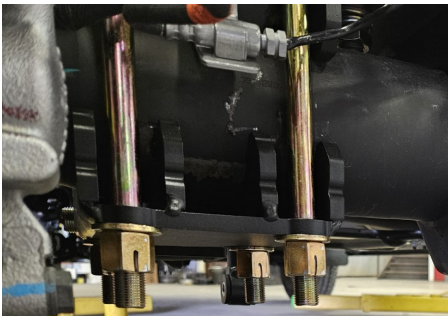

5/8"-18" x 8" or 5/8"-18 x 8-1/2" Bolts

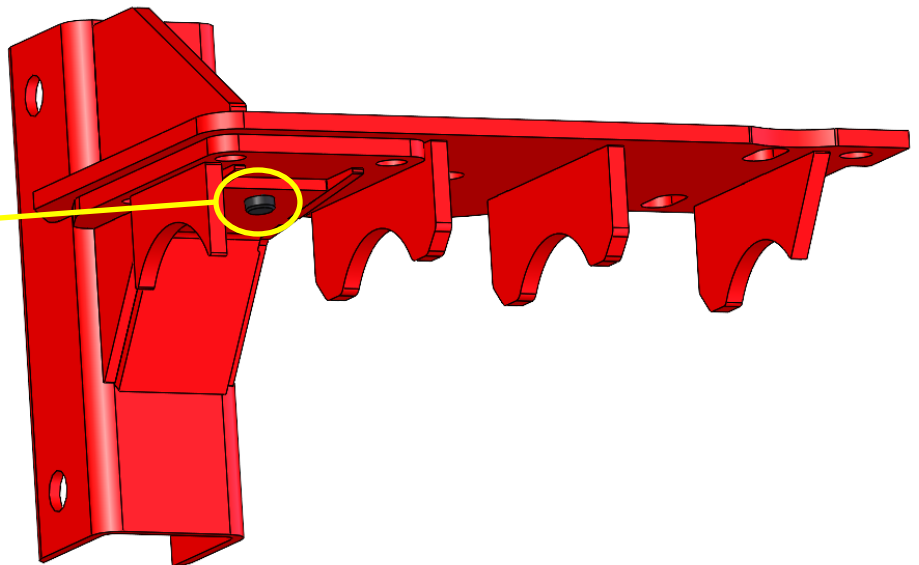

Use guide pin on lower bag weldment to line up the hole on the axle perch.

6) Once the upper, lower bag mounts and air bags are installed, lower the truck and line up holes in air bags with holes in the upper bags mounts. You will most likely only be able to install one bolt on each bag mount. The outside hole will be accessible and sufficient on both sides.



7) Zip tie the wiring harness for the sensor away from the exhaust so it does not get damaged from heat.



8) Locate the Crossmember (#10015132) and Brake Line Relocation Bracket (Part # 69712). These parts fasten to the lower airbag mounts with the U-bolt and the (4) 5/8" x 1-1/2" bolts. Torque the U-bolts to 55 ft./lbs. and the 5/8" bolts to 85 ft./lbs. The brake line relocation bracket mounts on the drivers side rear U-bolt. Fasten the bracket to the U-bolt. Torque the lower air bag mounts to 175 ft./lbs.

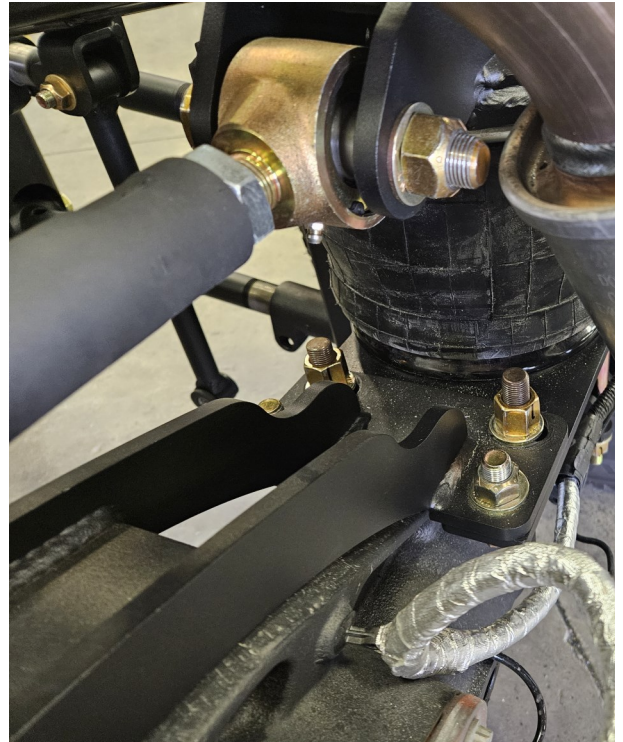

U-Bolt - 5/8"-18 x 8" x 4-1/2"

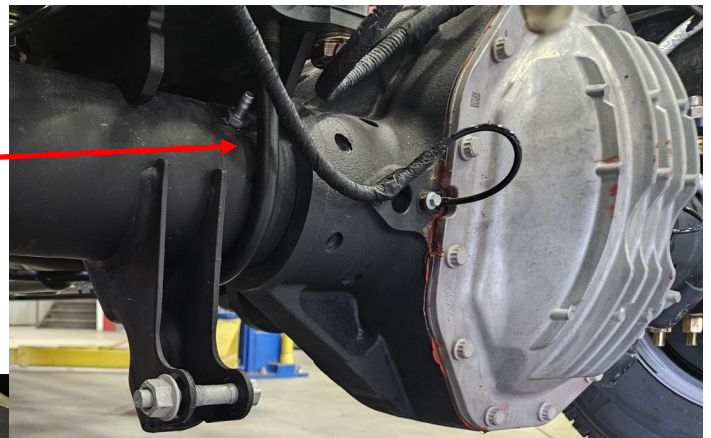

Brake Line Relocation Bracket

9) Locate the (4) Trailing Arm Bars (#52114.5). Adjust two of the trailing arms so there is 9-3/4" between the knuckles and set the other two trailing arms so there is 10" between the two knuckles. The 9-3/4" bars will be the top trailing arms and the 10" bars go on the on the bottom. The front bars attach to the forward trailing arm plate with the 7/8"-14 x 5" bolts and the rear trailing arms attach with the 7/8"-14 x 5" bolts. Do not torque the bolts until the install is complete. Once the air bags are set at ride height, you will torque the 7/8" bolts to 300 ft./lbs.

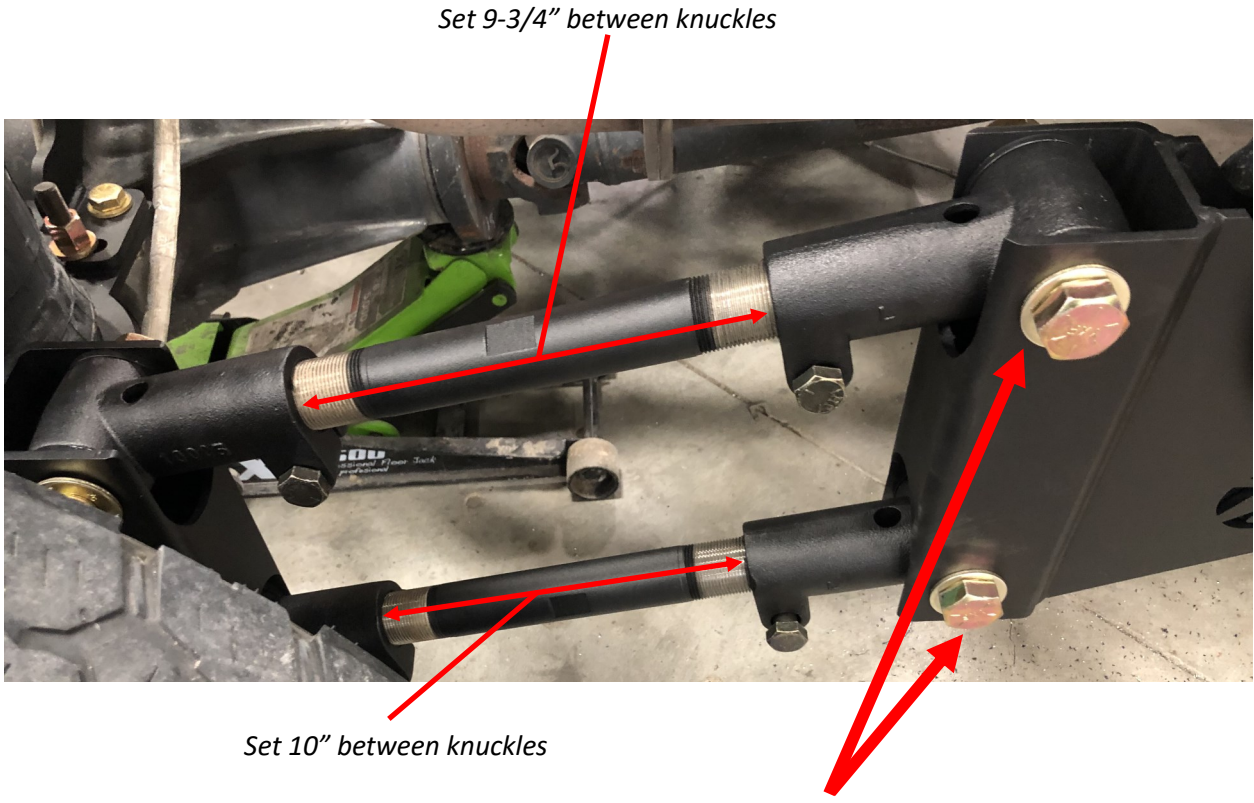

10) Locate the accumulator tanks (#69150 & 69151). These tanks fasten into the original rear leaf spring shackle mounts with the factory bolts. Make sure the large port for the 3/4" air fitting is pointing forward. Torque the factory leaf spring bolt to 135 ft./lbs. Once the air tank is secured within the mount, run the 3/4" air line from the large fitting in the air tank to the large fitting in the air bag. Torque the 3/4" nut on the bottom of the air bag to 35 ft./lbs.

← Front of vehicle

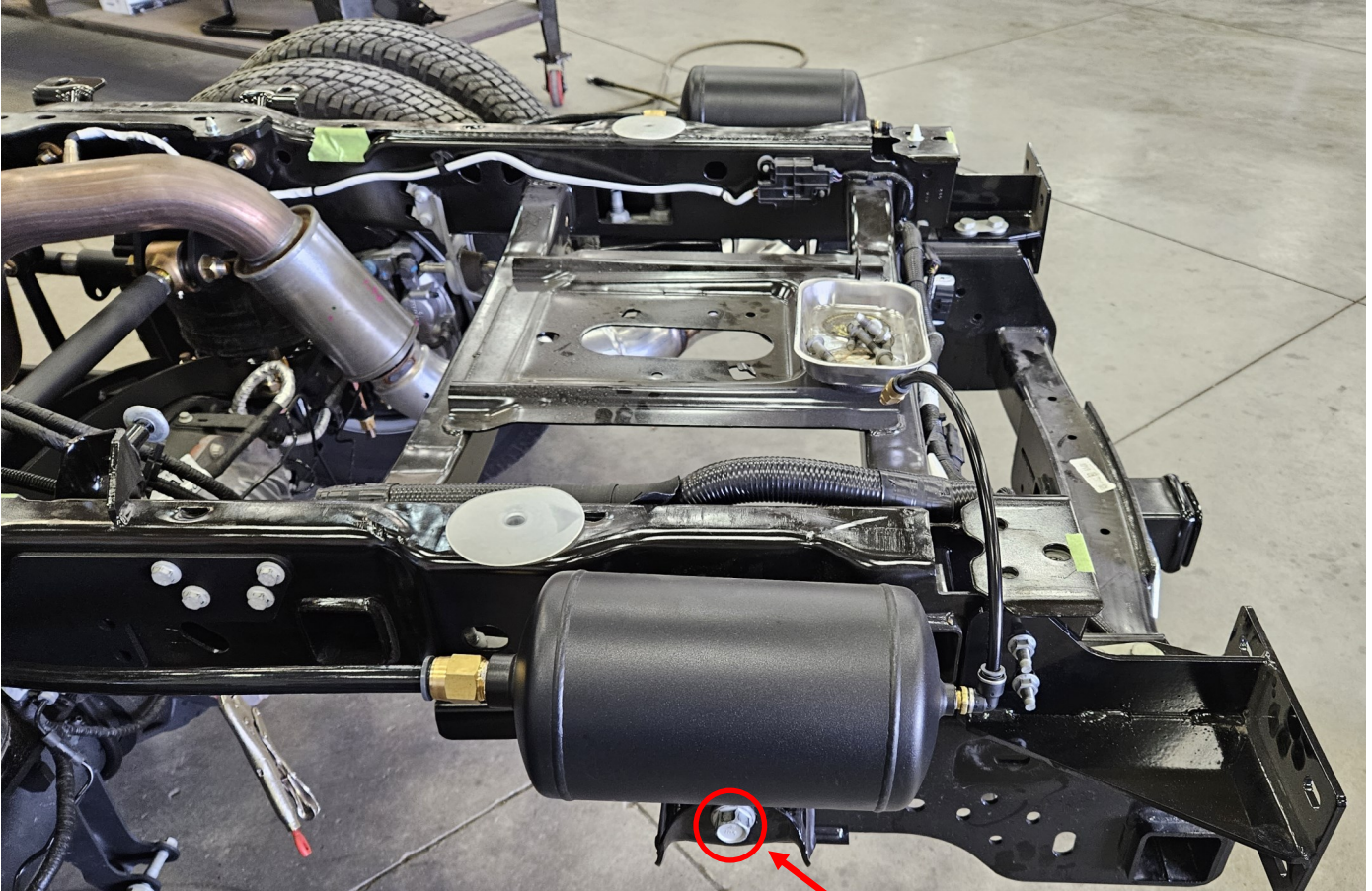

Torque this bolt to 135 ft./lbs.

Fitting will face towards the accumulator tank

11) Locate the Panhard Bar (#10007941). It fastens to the Upper PHB Mount and Crossmember with the (2) 3/4"-16 x 4" bolts. Torque the 3/4" bolts to 200 ft./lbs.



12) Locate the Shocks (#10003384/10006717). They fasten in the factory shock location with the factory shock hardware.



13) Locate the Sway Bar (#10009282), D-Ring Retainer (#80046) and Bushings (#80311). The sway bar fastens to the axle in the factory location (on the shock mounts) with the M10-1.5 x 35mm bolts. Once the sway bar is fastened in place, attach the end links to the sway bar with the 1/2"-20 x 2-1/2" bolts. Make sure to use the large machined washer (#11551) on the outside of the bolt head.

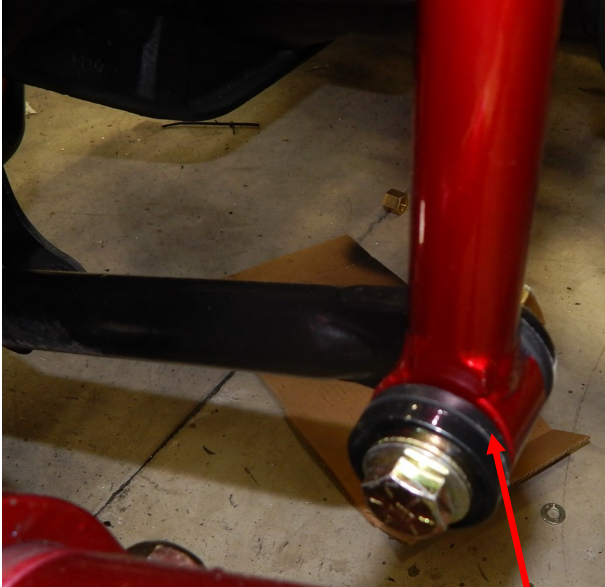

Flat washer shown



Driver Side

Use the supplied grease to prevent the sway bar from squeaking against the bushing



Passenger Side

14) Once the kit is installed, inflate the airbags to 8". This is the middle range where the airbag rides the best. It can run as low as 7" and as high as 9". With the air bags at the ride height you choose, measure off the front axle ball joints to make sure the axle is square with the front. When you test drive the truck, if the truck pulls to the right you will shorten the drivers side trailing arms one turn. This is how you decide which side of the axle needs shortened or lengthened when trying to eliminate the pull or drift of the vehicle.

Measure between the air bag mounting plates when measuring the height on the air bag

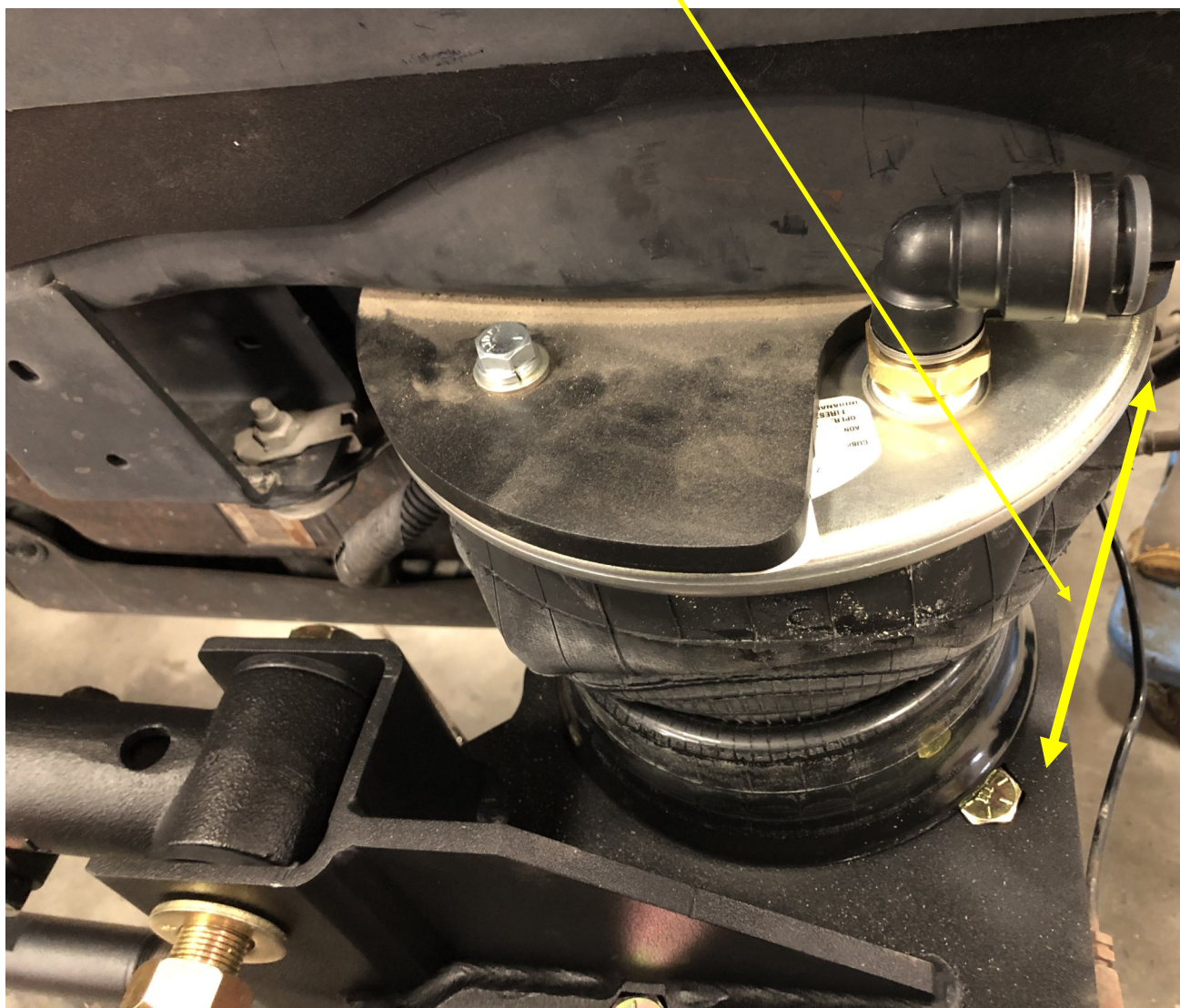

Hadley Sensor Mounting

15) There are two different types of height control devices used, mechanical and electronic. The Hadley electronic sensor is shown below. It mounts to the side of the frame with the sensor bracket (Part# 10011863-DS/10011897-PS). Reuse the factory bolts to attach the sensor bracket. The sensor attaches to the bracket with 1/4"-20 x 1-1/4" Socket Head Cap Screws. When setting the linkage length, set the air bag at 8" and make sure sensor arm is straight out. The body of the sensor probably will be orientated with the top bolt closer to the rear of the truck. The collar will fasten to the top trailing arm and be just behind the machined flats on the bar.

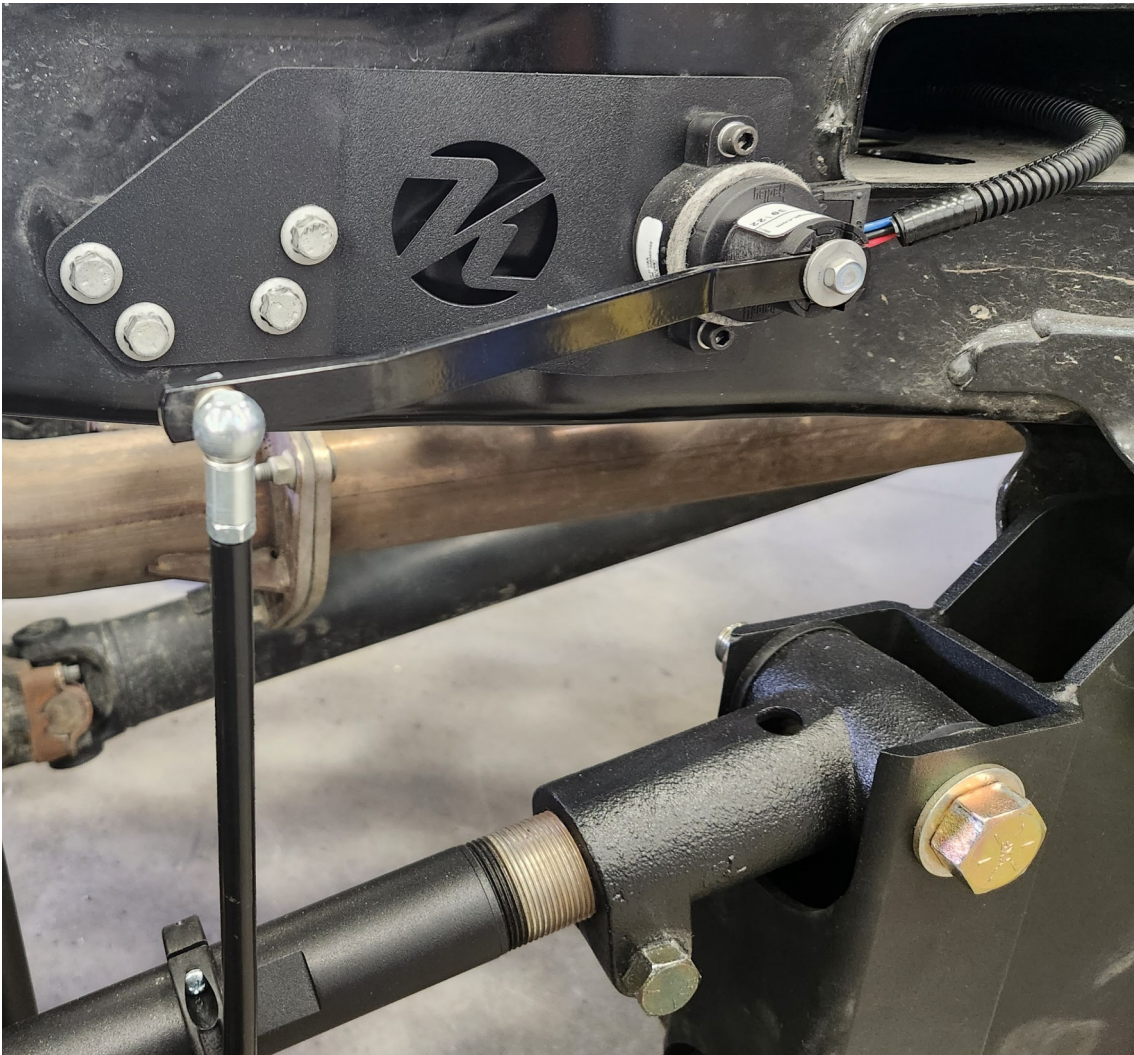

The sensor needs to be indexed so the arm of the sensor is going straight out from the wiring harness plug on the back side of the sensor. Put the bags at 8" and set the collar so it is against the threads. Next with the sensor arm parallel with the top trailing arm. Cut the linkage length so that the arm is parallel, pull the little lock clips out of the female sockets, press the female sockets on the ball studs and reinstall the locking clips. The sensor below is using a 8" arm and a 5-6" linkage. **NOTE: The sensor will work with a 6" or 8" arm. Also mechanical sensors mount using the same bracket. See next page for mechanical sensor instructions.**

Height Control Valve Mounting

The mechanical height control valve mounts to the frame just like the electronic sensor. It needs to be straight up and down when bolted to the frame and the arm is straight out at ride height. **NOTE:** *Before installing the mechanical valve, rotate the arm clockwise and counter clockwise 4-5 times each way. This will get the internals ready for operation after sitting in inventory after the valves production.*

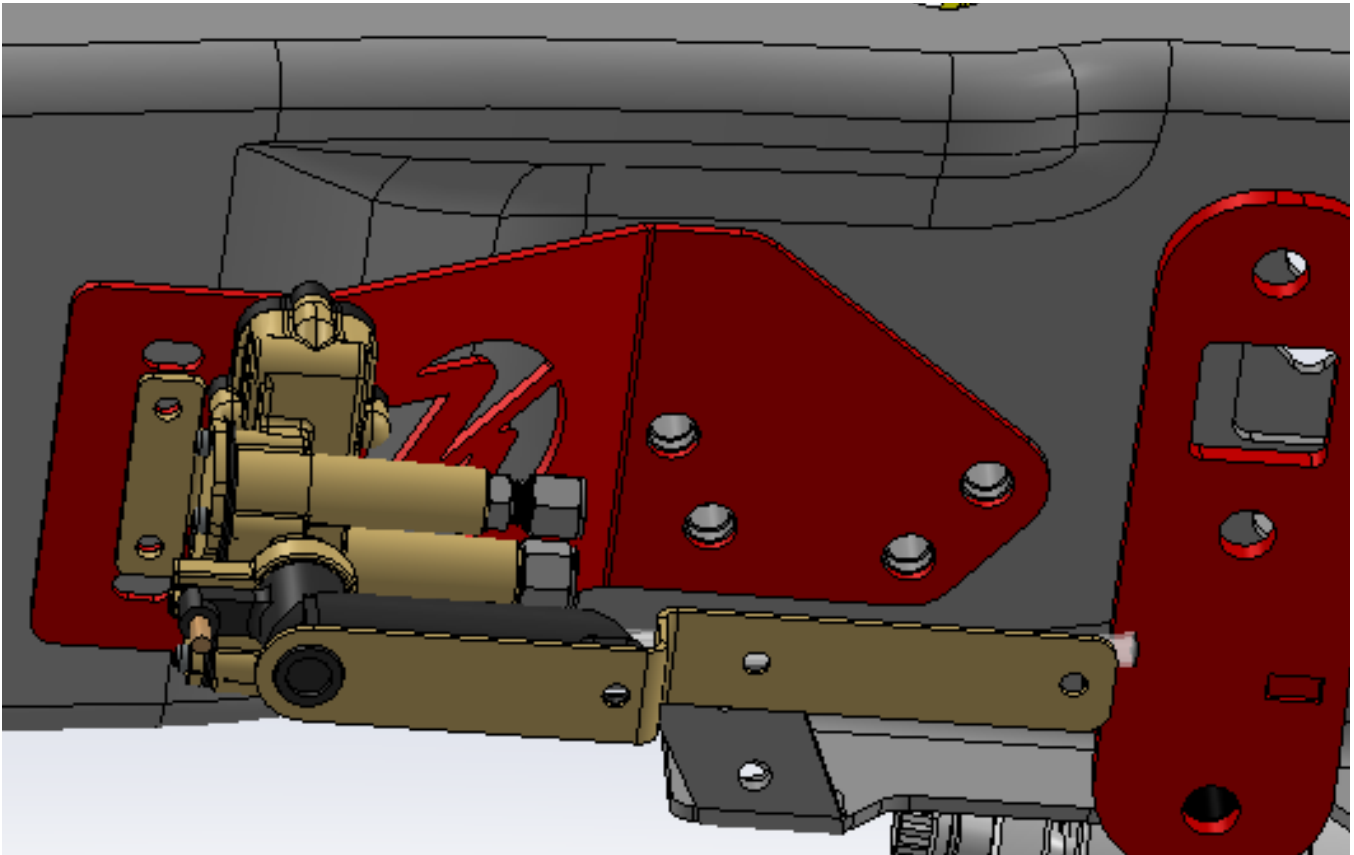

Mechanical Valve Mounting Tips

-The height control valves have an 8 second delay.

-Before installing the height control valves, rotate them 360 degrees each direction about 6 times.



Compressor Box Mounting

16) The best mounting location for the electronic air controls box and air tank is where the spare tire originally went. Use the supplied mounting brackets and weld them to the spare tire carrier. **Make sure to use a battery protection device on the batteries or unhook the batteries before welding!**

Mount one air tank beside the compressor box and mount the other tank on the front side of the crossmember. Refer to the picture on the next page.

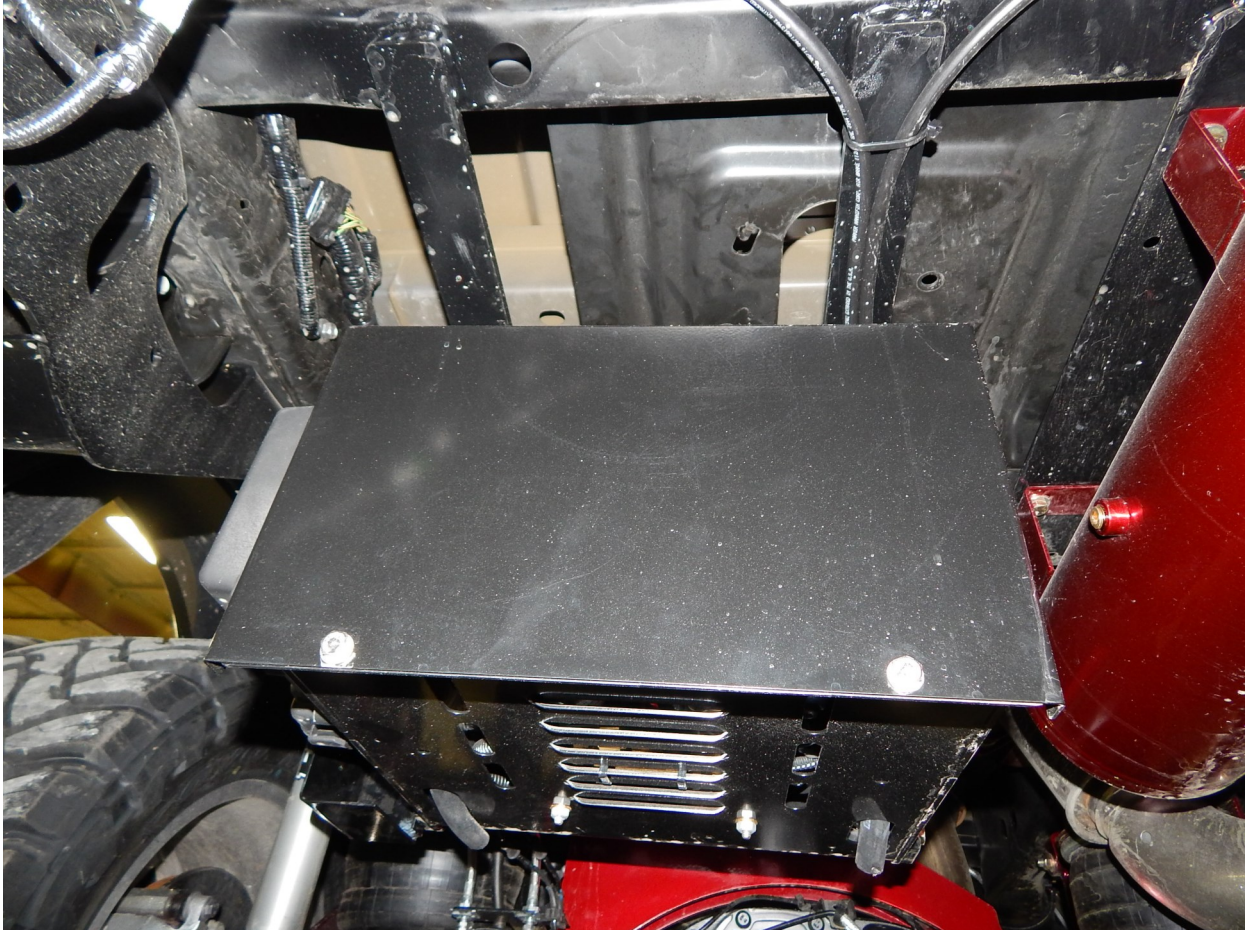

The air compressor box for the mechanical system will also mount where the spare tire normally is. The mechanical system normally only uses one tank, so you can mount it right beside the box.

These air control system mounting locations are merely suggestions. Controls can be mounted virtually anywhere on the truck, but these will be the most convenient and the recommended locations.

Compressor Box Mounting (continued)



Optional second tank shown mounted to the front of the cross member

FINAL DIMENSION SHEET

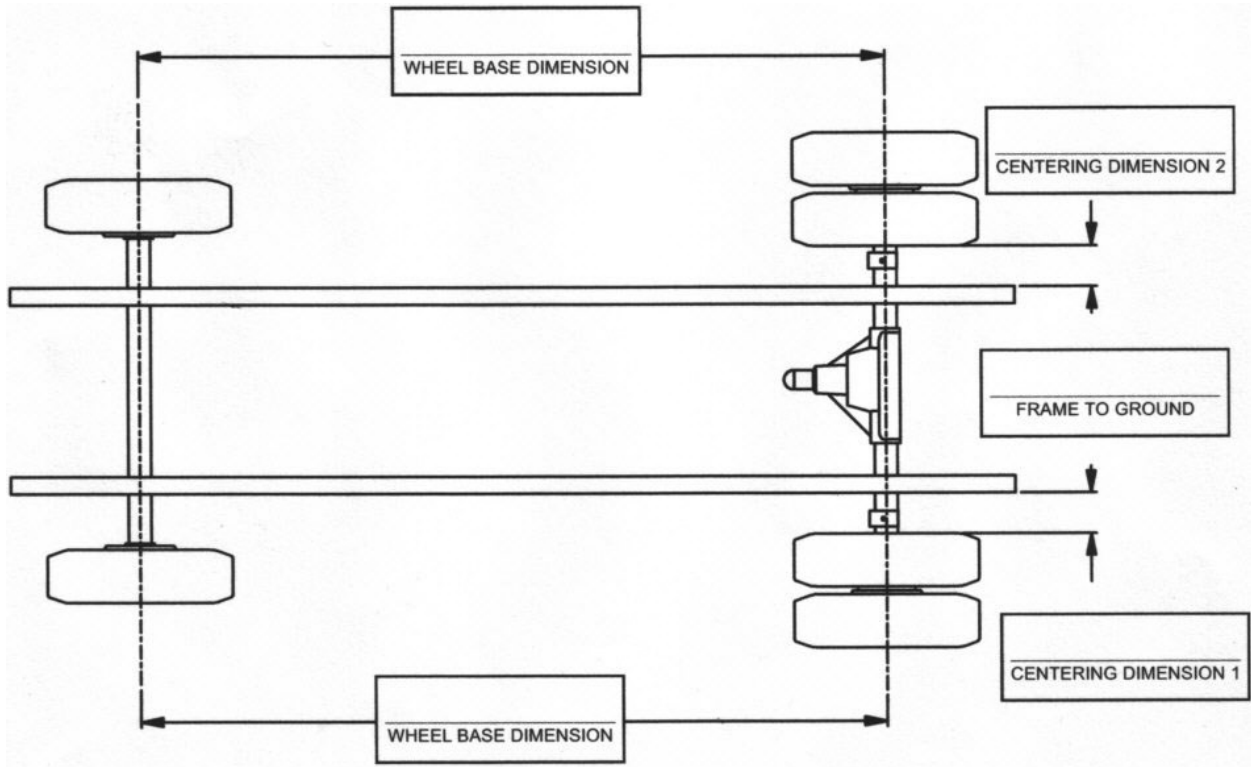

NOTES:

TROUBLESHOOTING GUIDE

<u>COMPONENT</u>	<u>POSSIBLE PROBLEM</u>	<u>CORRECTIVE ACTION</u>
Air lines	Air leaks	Replace air line.
Fittings	Air leaks	Remove fitting and apply fresh joint compound. Reinstall fitting, but Do Not Over Tighten. Do not use Teflon tape.
Air Bags	A. Improper height B. Air leakage	A. Adjust valve linkage to maintain proper air spring height.
Panhard Bar	A. Loose nuts on lateral control rod bolts. B. Worn bushings	A. Tighten securely. B. Replace lateral control rod.

Torque Chart		
Bolt Size	Bolt Grade	Torque Value (ft-lbs.)
3/8-24	GR8	25
1/2-13	GR5	55
1/2-20	GR8	65
5/8-18	GR8	130
3/4-16	GR8	175
7/8-14	GR8	250

OWNER GUIDELINES

The Kelderman suspension needs no lubrication and little maintenance. However immediate corrective action should be taken if a serious malfunction occurs.

CAUTION! If maintenance or service is to be done on the air system be sure to drain all air from the system. Serious injury could occur if components are removed while the system is full of air.

PRODUCT OWNER RESPONSIBILITIES

- Owner is solely responsible for pre-operation inspection, periodic inspections, maintenance, and use of the product as specified in the particular Kelderman Mfg. instructions available by product model, except as specified in this warranty, and for maintenance of other vehicle components. Of particular importance is the re-torque of fasteners including axle bolts, four link bolts, and pan hard bar bolts. This re-torque must be performed within 90 days of the suspension being put into service.
- Owner is responsible for “down time” expenses, cargo damage, and all business costs and losses resulting from a warrantable failure.
- The Kelderman Air Suspension is fully automatic in controlling the height of the chassis. No manual intervention to control air pressure is needed during the course of operation.
- On a mechanical control system the compressor switch must be on for the compressor to operate. During the starting circumstances, (i.e. extremely cold weather) it is recommended to turn the compressor switch off until the vehicle is running so it will not draw current from the battery. The compressor is controlled by the pressure switch located in the air control box. This switch automatically turns the compressor on when the tank pressure falls below the preset low point of the pressure switch and turns the compressor off when the tank pressure reaches the preset high point of the pressure switch.
- On a mechanical control system the low pressure warning light indicates a severe drop in the tank pressure (below 45 PSI). Immediate corrective action should be taken to determine the cause of air loss. Compressor switch should be turned off if low pressure warning light is on and remains on even after the compressor has run for a normal period of time. **NOTE: The low pressure warning light could come on briefly when the “dump” feature is being used.**
- It is important to release any moisture contained within the air tank on a regular basis. This is done by pulling on the attached release cable for approximately 5 seconds. Not releasing the moisture on a regular basis could cause the system to operate properly.
- On an electronic control system it is vital that you remove the main fuse located by the battery during any jump starting of the battery or replacement of parts.

CHECK AT EVERY VEHICLE SERVICE INTERVAL:

Check ride height to ensure that it is within 1/4”.

Check for air leaks around fittings.

CHECK AFTER THE FIRST 1000 MILES:

Recheck and tighten any loose fasteners.

Check for any loose or worn components.

CHECK AFTER EVERY 30,000 MILES:

Check trailing arm and pan hard bar bushings for wear; replace if worn.

Kelderman Manufacturing
Warranty Policy
2021



Kelderman Manufacturing Product Warranties, Disclaimers, and Warnings.

Kelderman Manufacturing, Kelderman Air Suspension (Warrantor), offers a product warranty to the original retail purchaser, with which whom owns vehicle on which the unit was installed, and with Commercial wholesale purchasers. Please see below for warranty terms.

It is the **Installer** and **Sellers** responsibility to review these warranties, warnings, and disclaimers with the consumer prior to installation.

Retail Customers:

3-year limited warranty from original invoice date for defects in materials and workmanship related to fabricated parts, i.e., upper or lower bag mounts or pan hard bar.

1-year limited warranty from original invoice date for defects on purchased parts, i.e., compressors, air bags, or a part that comes from an outside supplier.

Some products may come with their own warranties supplied by their manufacturer. If so, that warranty is passed onto you as the consumer. Please keep your original invoice as it will be needed for that warranty.

Warrantor reserves the right to request any product to be returned for further review/inspection before approving claims. In the case of a requested return, Warrantor shall provide shipping instructions.

Commercial Customers:

3-year/100,000-mile limited warranty from the date the unit was put into service for defects in materials and workmanship related to fabricated parts, i.e., upper or lower bag mounts or pan hard bar.

1-year/50,000-mile limited warranty from the date the unit was put into service for defects on purchased parts, i.e., compressors, air bags, or a part that comes from an outside supplier.

Labor will also be covered for commercial customers only. Labor is only a coverable expense, as long as part is covered under warranty program. Labor Rate is payable for \$75/hr, and an invoice must be supplied in order to be paid.

Warrantor must be contacted for warranty authorization before any diagnostic work or repairs are performed. At that time, Warrantor will provide diagnostic assistance and authorization for the repairs if warrantable. Any unauthorized diagnostic work performed before contacting Warrantor will not be covered under the warranty program, if deemed unreasonable. Defective parts must be returned to Kelderman Manufacturing as per warranty program, unless otherwise stated.

Kelderman Technical Line 641-673-5396 x130



Kelderman Warranty Line 641-673-5396 x135

Monday – Friday 7:00 am to 4:00 pm CST

Kelderman Manufacturing
Warranty Policy
2021



Warranty Terminations

The following actions or events will result in the automatic termination of this warranty and relieve Kelderman Manufacturing from any and all obligations under this warranty:

- Attempting to repair or alter the product in any way after purchase.
- Misuse or neglect of the product including accidents, improper installation, or application.
- Failure to operate or abuse vehicle in anyway, as determined by Warrantor.
- Vehicle being operated outside the recommended ride height as predetermined by Kelderman Manufacturing and set forth clearly by installation instructions.
- Vehicle has combination and/or substitution of other suspension systems in lieu of Kelderman products.

Warranty Does Not Cover

The following are items Warrantor will not cover in case of warrantable part.

- Finish of part, i.e., powder coat, paint, or plating.
- Warrantor is not obligated to cover any "down time" for vehicles to due warranty parts and/or availability of warranty parts.
- Damages to vehicle related/non-related to the installed Kelderman Air Suspension.
- Excessive freight charges, i.e., Next Day Air. As seen to be determined by Warrantor.

Warning

Kelderman Air Suspension Systems are designed to be installed, and run at the recommend ride heights provided by Kelderman Manufacturing. Failure to do so may cause premature wear and inhibit the suspension system from operating as designed. This may cause a vehicular accident leading to severe injury or death.

Disclaimer

Kelderman Manufacturing reserves the right to supersede, discontinue, re-design parts and/or applications and finishes of powder coat or paint as deemed necessary without written notice.

- Kelderman Manufacturing tries to ensure that suspension parts you receive fit the vehicle they were designed for, however due to unknown vehicle manufacturer's production changes and/or inconsistencies, We cannot be responsible for 100% fitment.
- All products not specifically called out can be referenced by call the warranty line listed at the bottom of the page.

Kelderman Technical Line 641-673-5396 x130



Kelderman Warranty Line 641-673-5396 x135

Monday – Friday 7:00 am to 4:00 pm CST