



kelderman.

AIR SUSPENSION SYSTEMS

2686 Highway 92 - Oskaloosa, IA 52577

phone: 641.673.0468 - fax: 641.673.4168

www.kelderman.com

2011+ Ford F-250/350/450 Pickup 4-Link Rear Installation Instructions

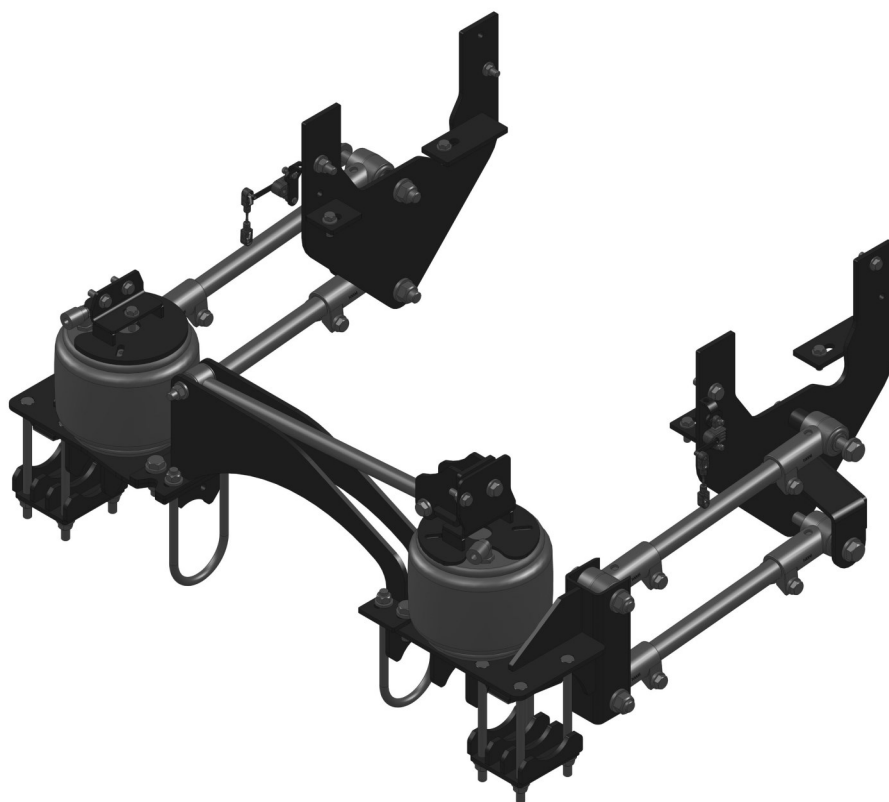

Installation

1. Before doing anything, measure the pinion angle and write the angle down. This is important because you will need to put the axle back to this measurement after the installation. Also, take a measurement from the front of the axle to a location on each side of the frame. Write these measurements here. Pinion angle _____. Right side _____ Left side _____ **NOTE: All the bolts in this kit use a flat washer on each side of the bolt.** It is not required to remove the bed, but if you have the ability to, it will make the install much easier.

2. Jack up the rear of the frame so that most of the tension is off the leaf springs. Place a set of jack stands under the frame, block the tires so the axle won't move and place a jack stand under the pinion so it doesn't rotate. Remove the leaf springs. If you are doing a mechanical height control system, remove the front overload pads. Remove the bolts that hold the sway bar to the axle and let it hang from the endlinks. Also, on the passenger side shock, remove the top of the shock from the mounting bracket and lean it forward. The best way to remove the riveted pads is to use a torch to cut the rivet heads off. Make sure that there are no fuel

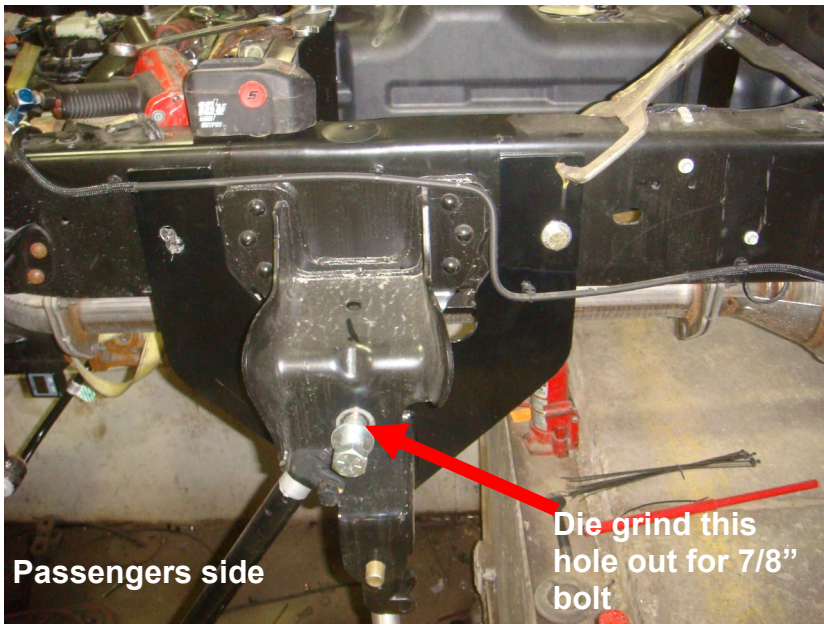

lines, brake lines, or wiring that can be damaged while cutting the rivets off.

3. Locate the front trailing mounts (part# 70508ds, 70509ps). These bolt to the front leaf spring mount with a 7/8x7 1/2" bolt. You will have to die grind out the hole about 1/32" to get the bolt through. Next use the 5/8x 2" bolt to fasten the rear hole. The front hole will have to be drilled as well as

one hole in the lower bracket that connects the side mount to the bottom of the frame. Use the 1/2x 1 1/2" bolts in the bottom of the frame. **DO NOT TIGHTEN ALL THE BOLTS UNTIL THE TRAILING ARMS ARE INSTALLED IN STEP 7 (1/2"-85 ft/lbs, 5/8"-150 ft/lbs)** Repeat on the drivers side. The fuel tank cover will have to be trimmed to allow for the trailing arm mount to attached. See picture on next page. **MAKE SURE TO PUT SOMETHING IN BETWEEN THE FRAME AND FUEL TANK WHEN DRILLING THE HOLES IN THE DRIVERS SIDE** so you don't drill a hole in the fuel tank or fuel lines.

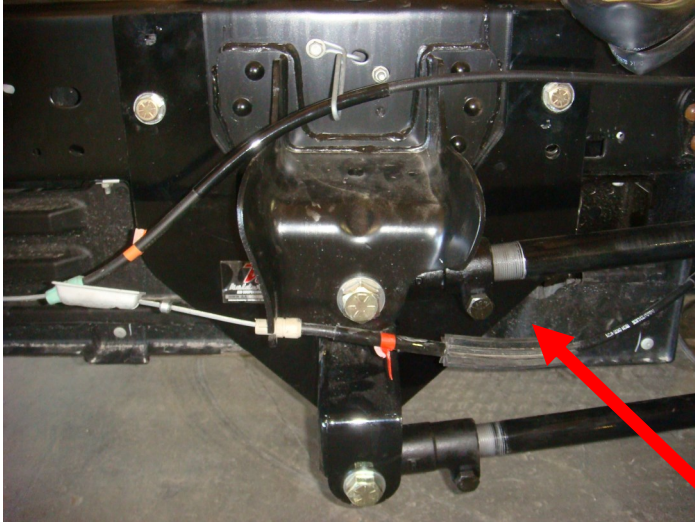

Drivers side forward trailing arm mount installed.

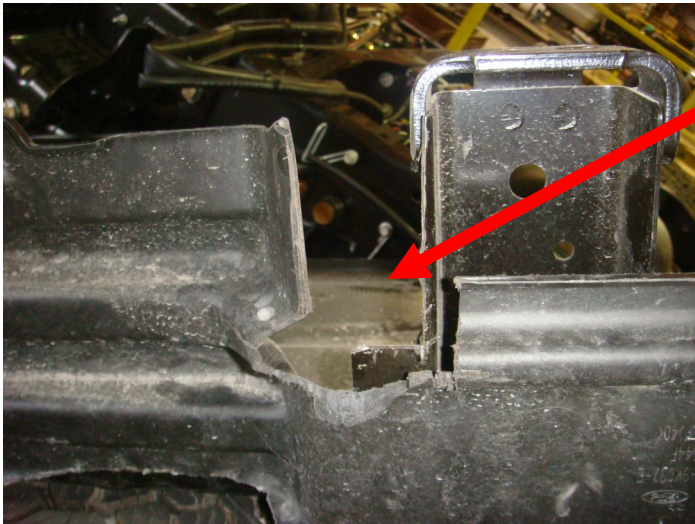

Notch the fuel tank cover so for clearance for the forward trailing arm side mount (drivers side)



Sway bar dropped from the axle. Passenger side shock attached at the bottom mount only. The strap is used to keep the pinion angle somewhat close to the correct setting.

4. Locate the lower bag mounts (part# 70501ds, 70502ps) 1/8" spacer shims (part# shim-.125), lower axle clamps (part# 70510) and eight 5/8x9 1/2" bolts. Put the 1/8" shim on top of the axle perch and install the lower bag mount on top of the shim/leaf spring perch. Drop the 5/8" bolts down from the top. Slide the lower axle clamp up to the bolts and fasten with the flat washers and nuts. Use a criss cross pattern when tightening. Torque to 150 ft/lbs.

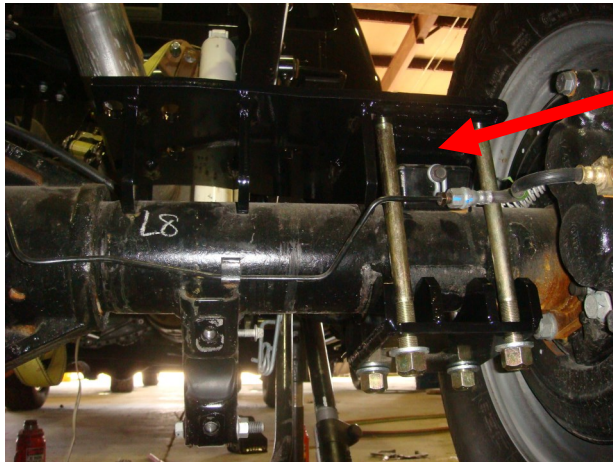
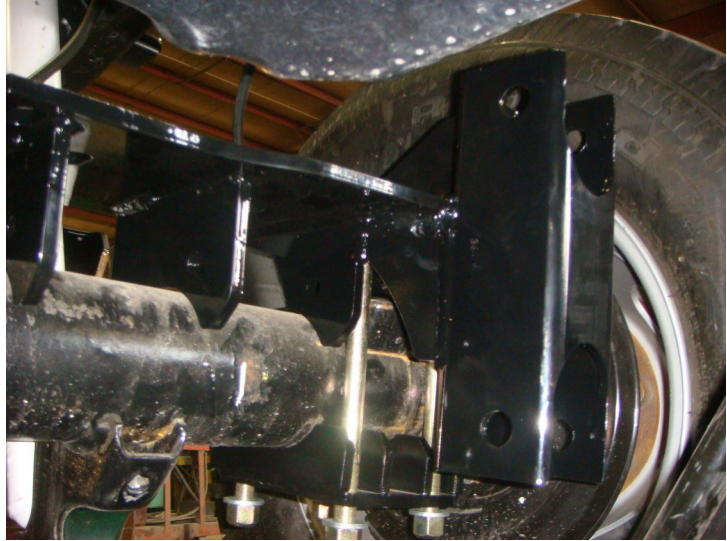

1/8" shim goes in between lower bag mount and axle pad

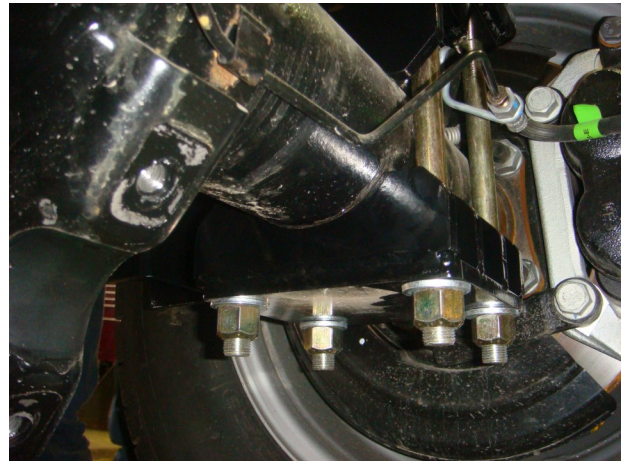

5. Locate the upper bag mounts (part# 70507ds, 70506ps) and the upper panhard bar mount (part# 70504). Remove the factory bump stops off the bottom of the frame. Use this hole fasten the drivers side upper bag mount in place with the 1/2x1 1/2" bolts. This hole is 3/8 from the factory. You will need to drill it out to 1/2" Next you will have to drill two 1/2" inch holes in the side of the frame. On the passengers side you will locate the panhard bar mounting bracket and place it on the inside of the frame. Use the 1/2x2" bolt in the bottom factory bump stop hole and the 5/8x2" bolt in the side of the frame. Then drill out the 1/2" hole in the side of the frame. Torque all the 1/2" bolts to 125 ft/lbs and the 5/8" bolt to 175 ft/lbs.

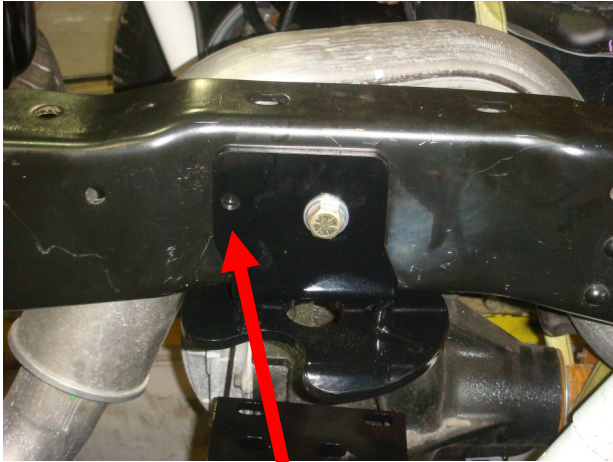

Passenger side upper air bag mount drill the front hole 1/2"



Drivers side upper air bag mount Two 1/2" hole needs drilled



Passenger side panhard bar mount





6. Locate the lower panhard bar cross member (part# 70503) and panhard bar (part# 70505). The crossmember fastens to the lower air bag mounts with the two 1/2" u bolts, and four 5/8x2" bolts. The panhard bar uses a 5/8x4 1/2" bolts on the drivers side. Make sure to put a spacer on each side of the bushing. On the passengers side, use the 5/8x4" bolt. The passengers side does not use spacers. Do not tighten any of these bolts until you get the trailing arms installed in step 7. Then go back and torque



Make sure to put a spacer on each side of the bushing. On the passengers side, use the 5/8x4" bolt. The passengers side does not use spacers. Do not tighten any of these bolts until you get the trailing arms installed in step 7. Then go back and torque

Spacer on each side of panhard bar

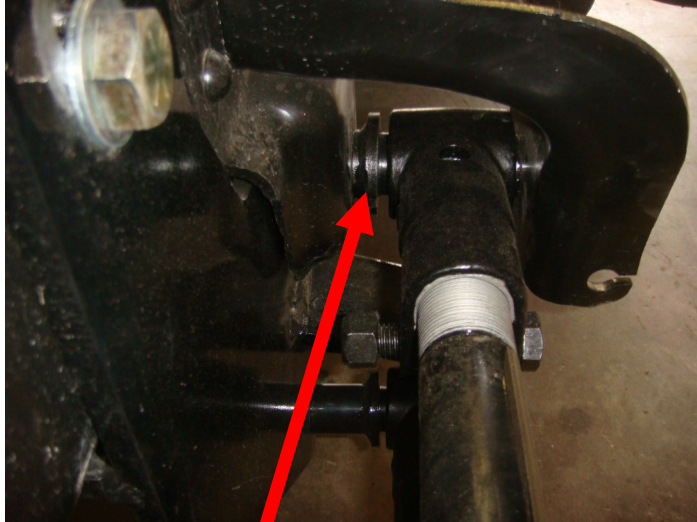

9/16 upper spacer goes on upper trailing arm

2" spacer goes on lower trailing arm

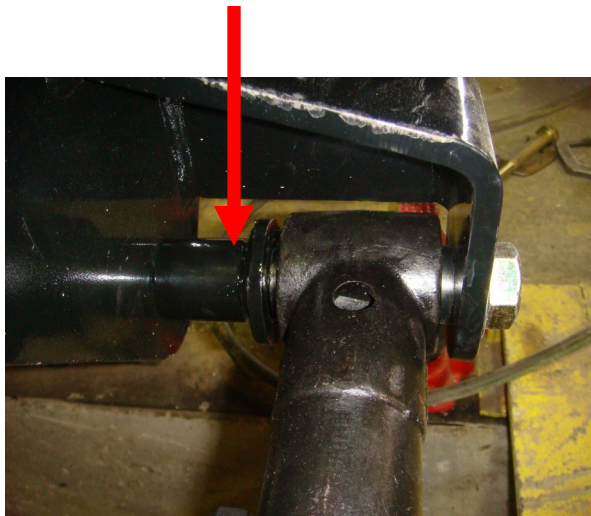

Insert bolts so the head is away from frame

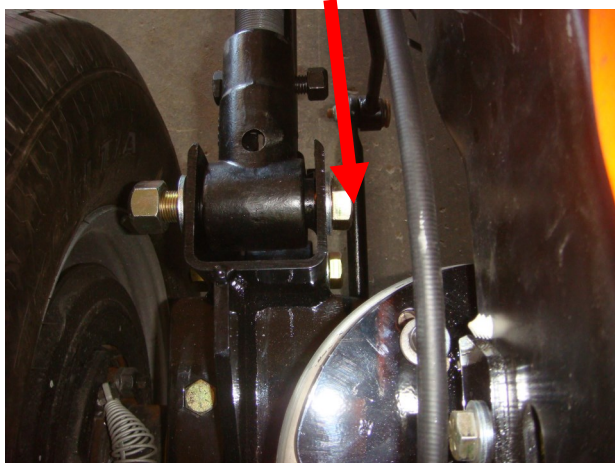

7. Locate the four trailing arms (part# 14891), upper and lower spacers, four 7/8x7 1/2" bolts, and four 7/8x 5" bolts. Use the 9/16" spacers on the upper trailing arms, factory leaf spring perch. They go on the inside between the cast knuckle and spring perch. Use a 7/8x7" bolt here. The other end of the trailing arm connects to the lower air bag mount. Use the 7/8x5" bolt there. Insert the bolt from the inside out so the nut side is away from the frame. If not, the bolt may rub on the frame. The lower trailing arms mount to the forward trailing arm mount using the 2" spacer and 7/8x7 1/2" bolt. The rear fastens to the lower bag mount with the 7/8x5" bolt. The upper arm will measure around 17" between the knuckles and the bottom will be around 16 1/2". This will get you close to the correct wheel base and pinion angle. When adjusting the trailing arms, the panhard bar should be in the middle of the cross member. Some fine tuning will be required from here. Do not tighten these bolts yet. Once the install is complete, they will need to be torqued to 350 ft/lbs.

Top bar 17"
between
knuckles

Bottom bar
16 1/2" be-
tween



8. Locate the 5748 air bags (part# 10589-4), 2 accumulator air tanks and 3/4" air line. The air bags fasten in place with one 3/8x 1" bolt, flat washer and lock washer to the upper bag mount and a 5/8" nut and lock washer on the bottom bag stud. Insert the 90 degree air fitting and tighten into the top of the bag. Use Teflon tape on the fitting threads. The accumulator tanks mount to the rear factory leaf spring shackle perch with the factory bolt. Make sure to mount to the large port faces forward. Insert the straight fitting in the tank. Use Teflon tape on the treads. The rear tank port uses the 1/4" air line fitting. Again use Teflon tape on the treads (unless it is supplied with it). Cut the 3/4" air line around 22" long and connect the tank to the air bag.

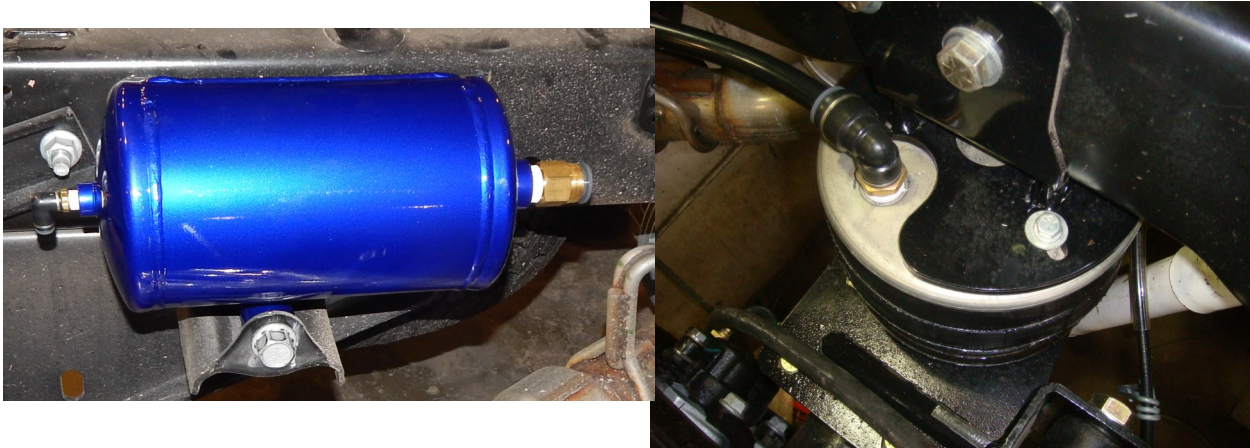

9. Locate the air tank and fittings. The air tank fastens to the rear factory cross member in front of the rear tire. Put one 90 degree fitting in the air tank. All the rest of the ports get plugged. Remove the rear tire before you drill the holes for the air tank. Hold the tank up and mark the 4 holes. Drill the holes and fasten with the 3/8x1" bolts
10. Locate the rear sensors (electronic system). For mechanical system, go to the next page. They fasten to the sensor mount with two 1/4x 1" bolts. Fasten the plastic collar to the upper trailing arm with the ball inside. Connect to the sensor with the linkage arm.



Air tank only uses one air line on the electronic system

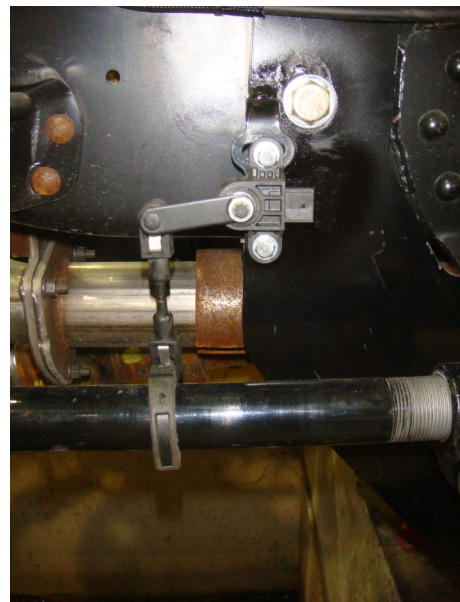

11. Go to page 10 and see how to modify the upper brake line mounts to prevent brake line damage when dumping all the air out of the suspension.
12. Go to page 12 for sway bar installation.
13. Locate the air compressor box. The box mounts under the truck on the drivers side in front of the fuel tank. Use the 3/8x4 1/2" bolts to fasten the box to the frame. Use the instructions for the air control system to plumb and wire up.
14. Alignment. You will adjust the four link bars to get the original wheelbase and original pinion angle. Refer to your original measurements in step one. The best way to do this is to put a jack stand under the rear hitch. Do this with the air bags measuring 7 1/2-8" tall. This measurement is between the upper and lower bag mounts. Now adjust the trailing arms by getting the upper and lower arms the same length. Turn each arm 1/2 turn at a time. If you get the arms over one turn off from each other they will bind up.
15. Once the alignment is done, go back and torque the 7/8" bolts to 320 ft/lbs. Torque the trailing arm set bolts to 85 ft/lbs. Go back and double check the rest of your bolts to make sure they are torqued.

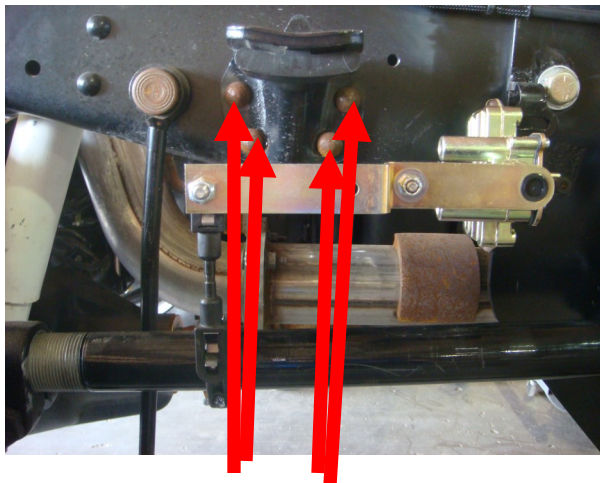

Mechanical system The leveling valve connects to the sensor mount with the 1/4x1" bolts. When using the mechanical valve it is required to cut off the overload pad rivets. Use a torch to do this. Make sure not to burn any wiring or brake lines when cutting. Use the diagram on the next page for plumbing of the system.

Cut these four rivet heads off with a torch

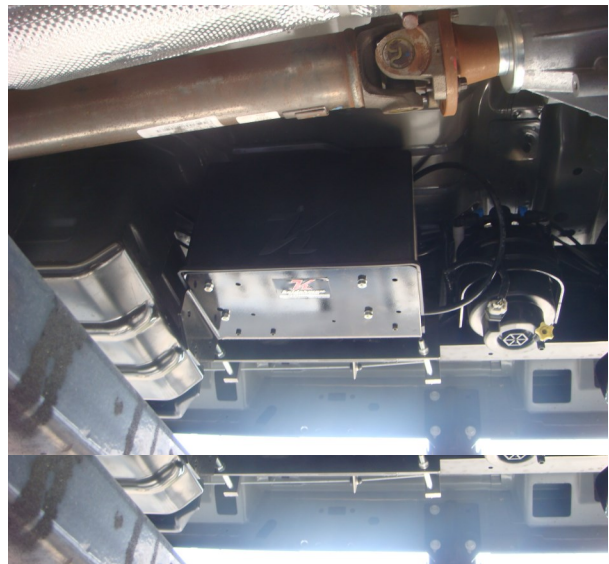

The rear upper dual brake line bracket needs to be modified in order to prevent damaging the brake lines when dumping the air suspension. Cut the bracket in the bed, then bend the bracket forward to gain added clearance. The upper bracket will hold it in place so it doesn't need to be welded.

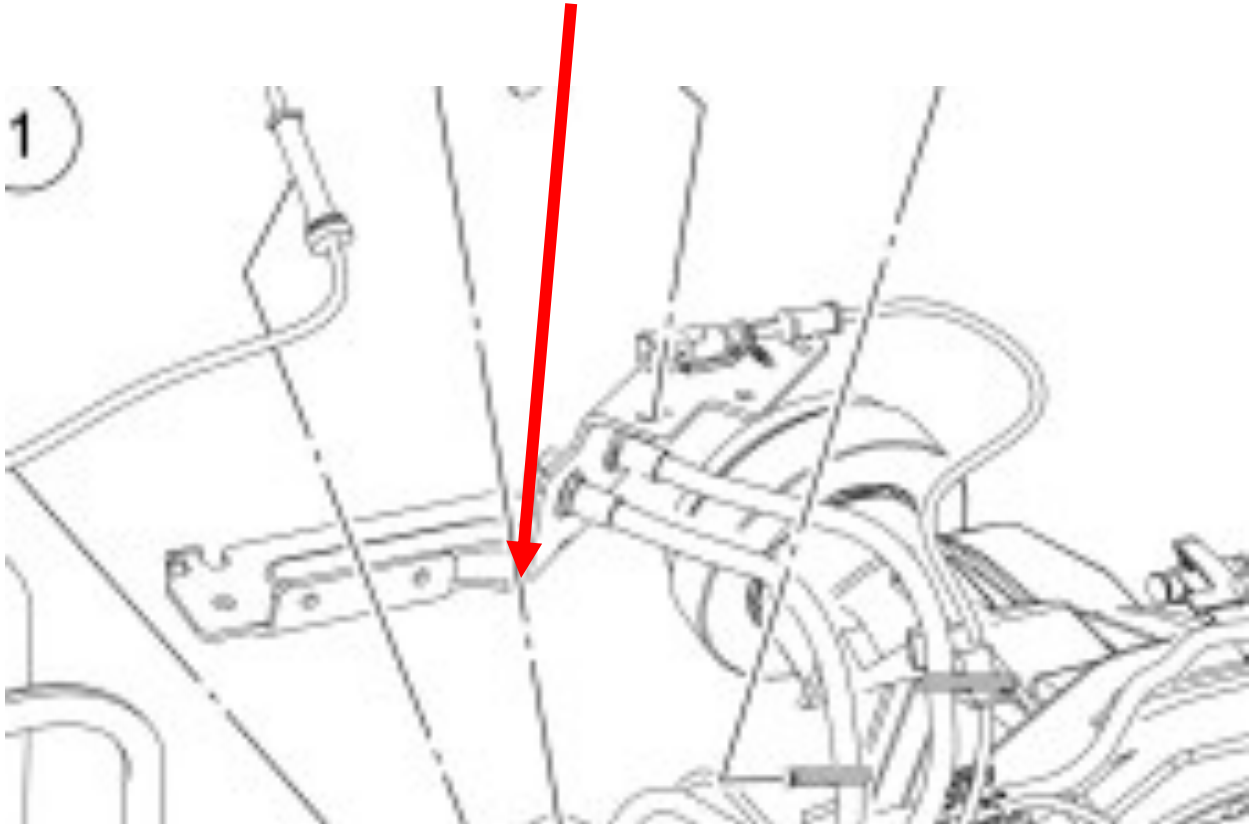

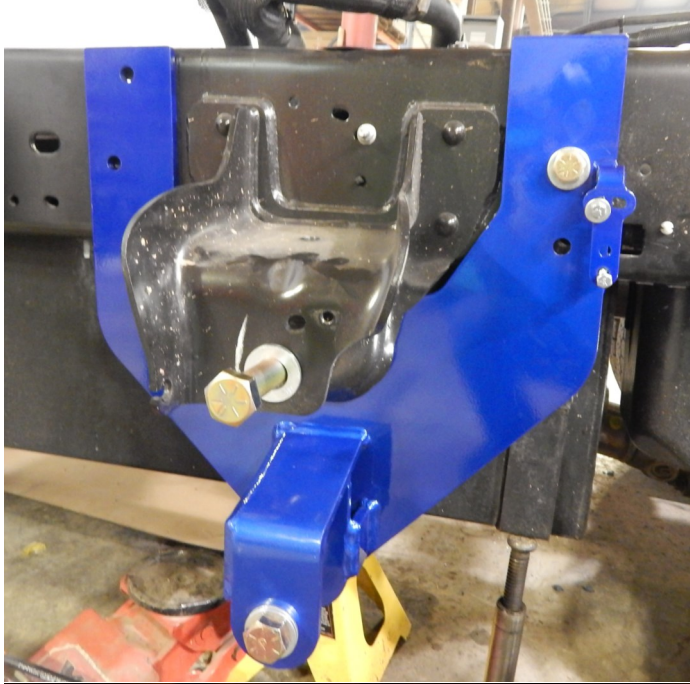

Additional pictures

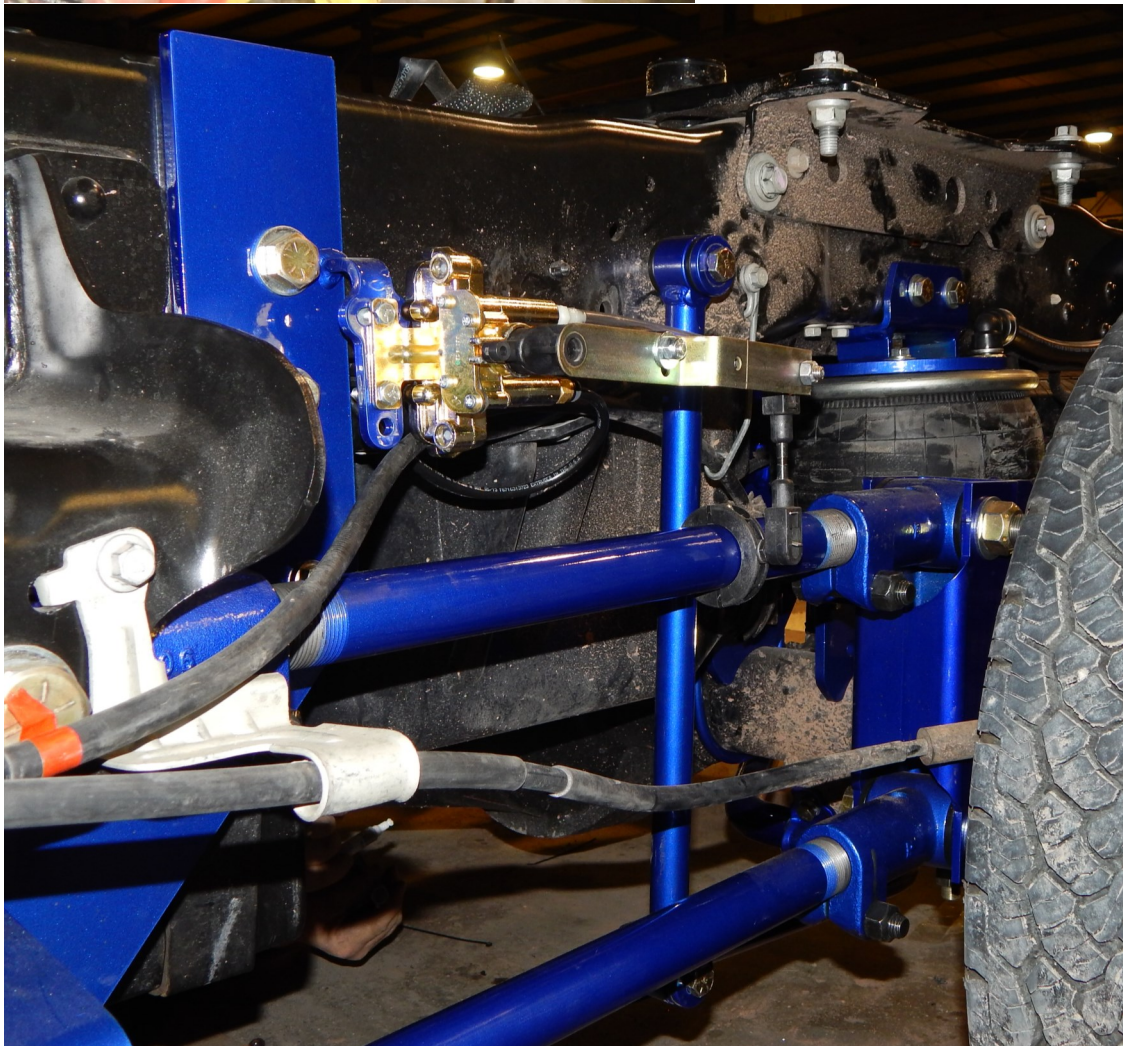

Factory hole

Thick washer on outside

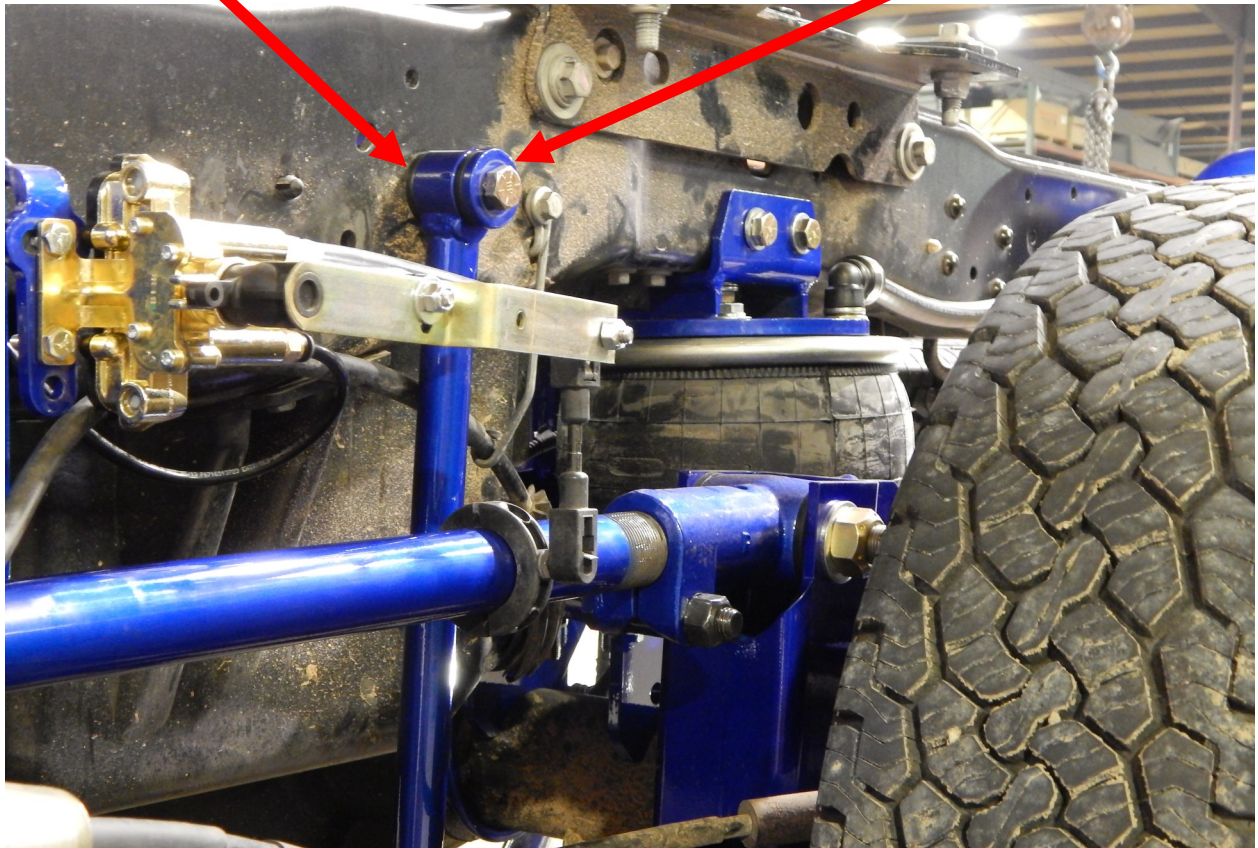

The original factory sway bar can be used with the Kelderman 4 link. A larger (1 3/8") unit is available and is shown on page 12. It fastens to the axle in the original location. The larger sway bar does use different end links. The end links fasten to the sway bar with the 1/2x3" bolts. Make sure to use the large washer on the outside of the end link against the poly bushing. The upper end of the end link goes into the truck frame. You will be able to find an existing hole and drill it out to 17/32". The sway bar should set level when the air bags have 8" of air in them. Play it safe and hook up one sway bar before you drill the opposite side and run the bags fully inflated to fully deflated. Make sure the sway bar does not hit on the differential cover. If so move the upper end up or down as needed for proper clearance.

Electronic Plumbing & Wiring Diagram with Air Dryer

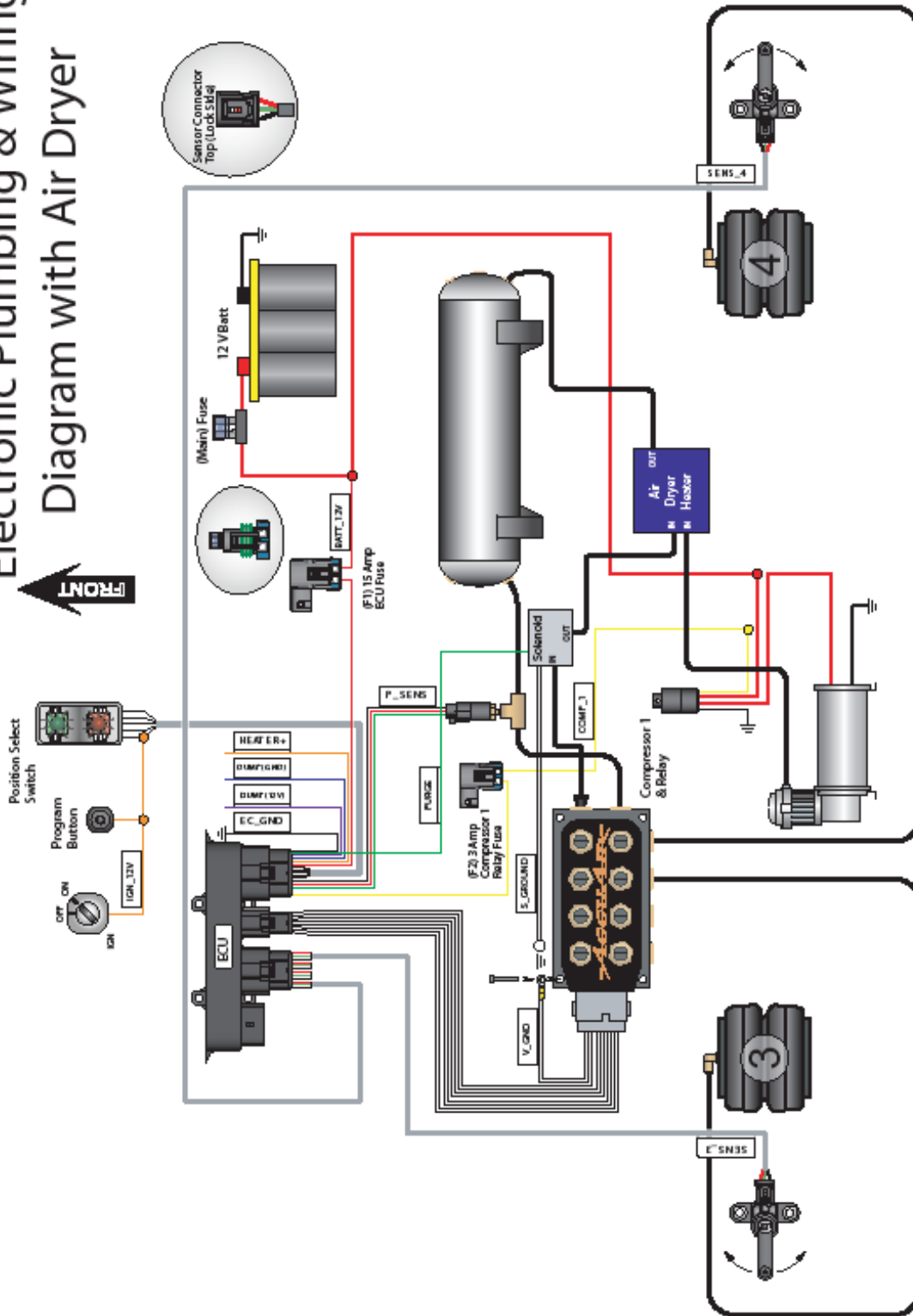

Compressor Box Self-Leveling Kit Wiring Diagram (shown with optional dump valve)

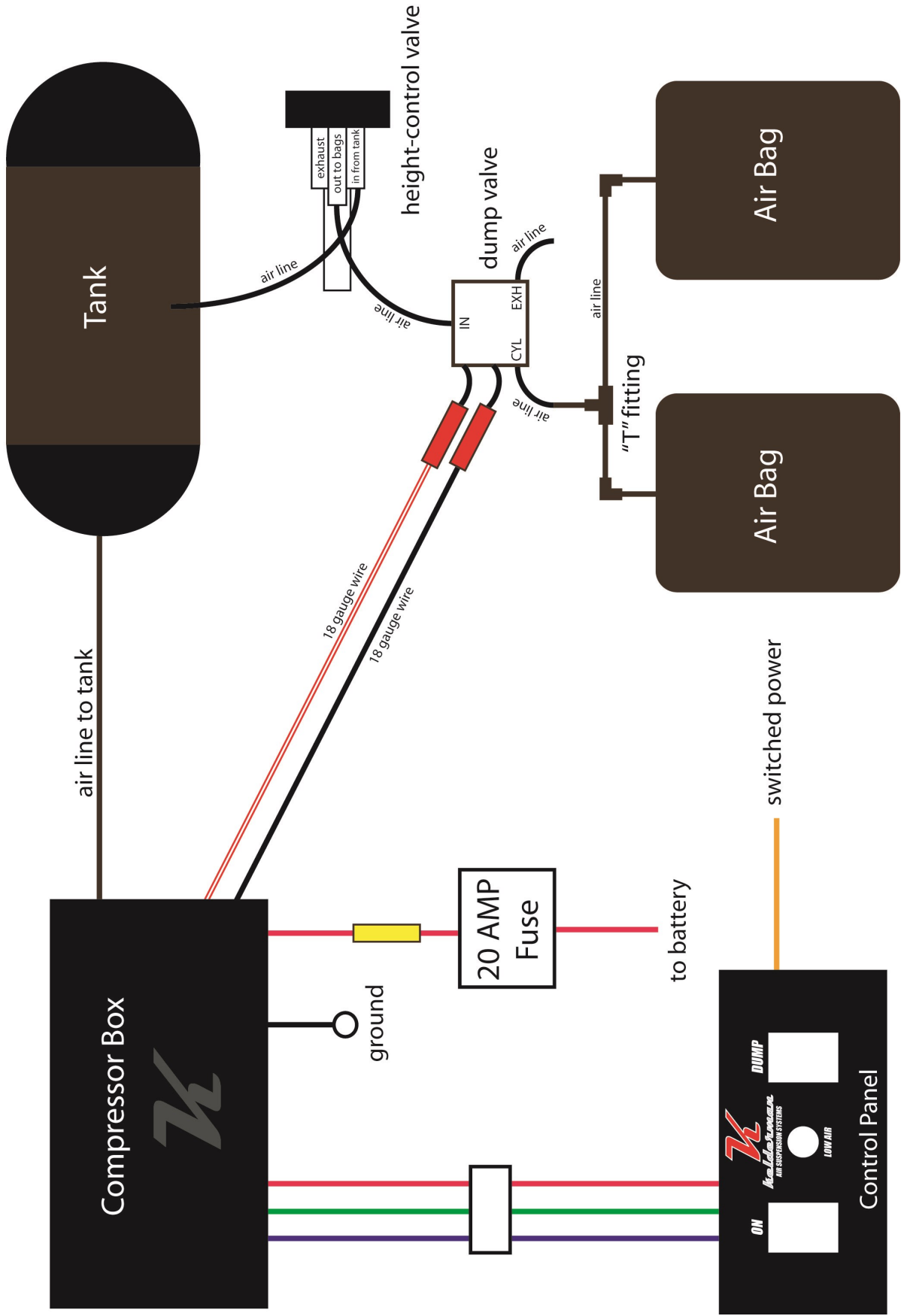

Front sensor mounts (for ESLK4 control systems) (Optional)



Drivers



Passenger side

Mechanical valve mounts
to the frame drill and tap
for 1/4-20 bolt.



**2011 FORD
KLM-70500
4-LINK REAR**

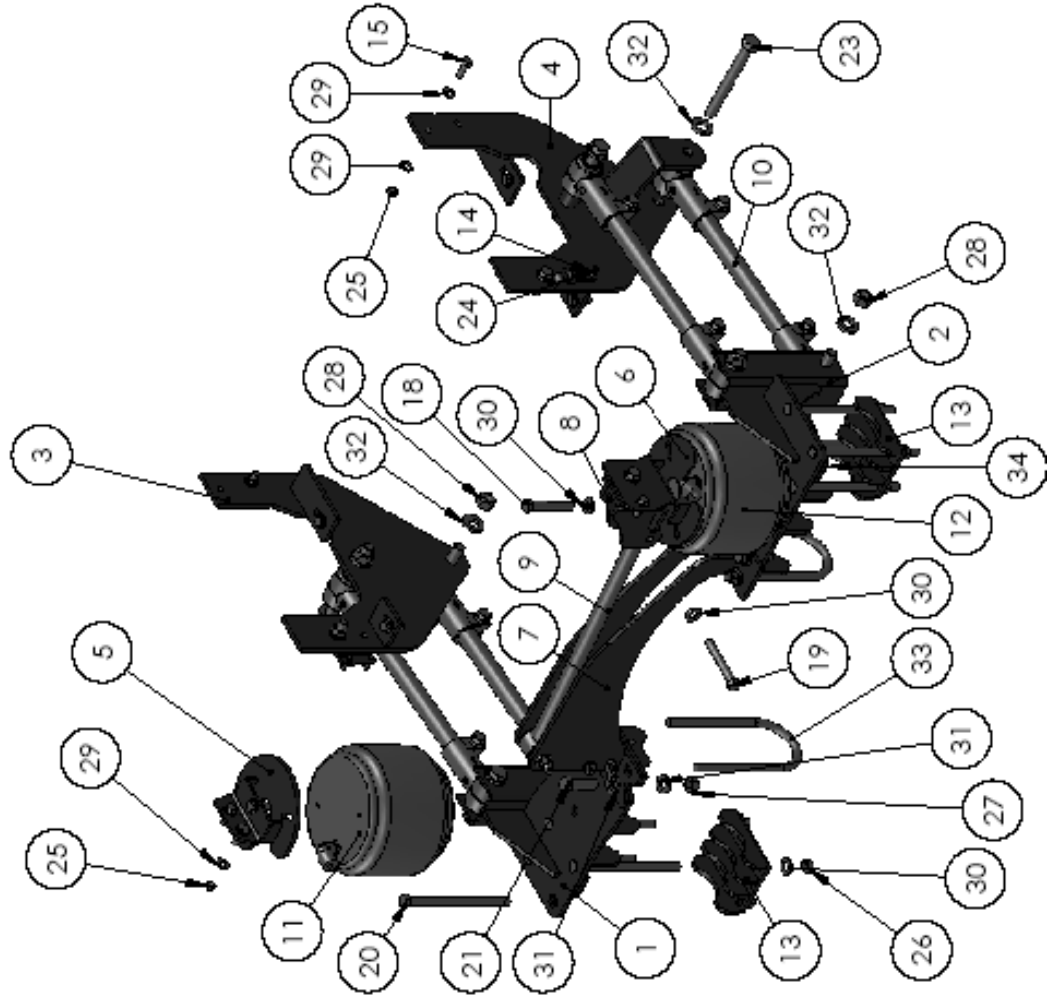

ITEM NO.	PART NUMBER	DESCRIPTION	QTY.
1	70501	LEFT LOWER BAG MOUNT (DS)	1
2	70502	RIGHT LOWER BAG MOUNT (PS)	1
3	70508	LEFT FRONT SIDE PLATE	1
4	70509	RIGHT FRONT SIDE PLATE	1
5	70507	LEFT SIDE TOP BAG PLATE	1
6	70506	RIGHT SIDE TOP BAG PLATE	1
7	70503	CROSSMEMBER	1
8	70504	UPPER PHB BRACKET	1
9	70505	PHB 23 3/4"	1
10	14891	Trailing Arms 22"	4
11	10589-4	FIRESTONE AIRBAG #5748 -	1
12	10589-4	FIRESTONE AIRBAG #5748 -	1
13	70510	CLAMP - LOWER 4.0 AXLE	2
14	12111	BOLT-1/4"-20 X 1" GR8	4
15	12007	BOLT - 1/2"-20 X 1 1/2" GR8	11
16	12409	BOLT - 5/8"-18 X 2"	2
17	12415	BOLT - 5/8"-18 X 2 1/2"	1
18	12427	BOLT - 5/8"-18 X 4"	1
19	12431	BOLT-5/8"-18X 4 1/2"-GR8	2
20	12471-1	BOLT - 5/8"-18 X 11" GR8	8
21	12517	BOLT-.75-18X2.50	4
22	12629	BOLT - 7/8"-14 X 5" GR8	4
23	12649	BOLT - 7/8"-14 X 7 1/2" GR8	4
24	13100	HEX NUT-TLHEX-.25-20-C-YZ	4
25	13144	HEX NUT - 1/2"-13 GR8	11
26	13146	HEX NUT - 5/8"-11 GR8	18
27	13148	HEX NUT-TLHEX-.75-10-C-YZ	4
28	13150	HEX NUT-TLHEX-.88-9-C-YZ	8
29	13004	1/2" FLAT WASHER	22
30	13006	5/8" FLAT WASHER	24
31	13008	3/4" FLAT WASHER	8
32	13010	7/8" FLAT WASHER	16
33	U-bolt	UBOLT	2
34	shim-.125	1/8" shim	2