

F4F4-23-X-11-10



Red Loctite is re-
quired

kelderman

AIR SUSPENSION SYSTEMS

2686 Highway 92 - Oskaloosa, IA 52577

Phone: 641.673.0468 - Fax: 641.673.4168

www.kelderman.com

2011+ Ford F250/350 4X4

Front 8-10" Lift Kit

Installation Instructions



1. Before you remove anything off the truck, measure the pinion angle on the bottom of the differential. Make sure to record the measurement here _____. Once the kit is installed, it is required to put the axle back to this measurement. This will keep the correct caster and camber.
2. Remove the transmission skid plate and then remove the driveshafts. Disconnect the front sway bar end links and remove the front sway bar. Place a jack under the differential and lift the truck until the wheels are 4-5" off the ground. Place a jack stand on each side of the frame, right under the radiator support. Remove the tires, shocks, steering arm, pitman arm and factory steering stabilizer shock. Let the jack down and remove the coil springs (they should have little tension left on them). Remove the cup on top of the axle that held the bottom of the coil in place, as well as the 8mm bolts that hold the ABS wire in place. Also, remove the upper brake line bolt that holds the brake hose located by the rear side of upper coil bucket.
3. Remove the factory trailing arms. Remove the yellow bump stop and remove the bolt that held the mounting cup in place. These will not be reused. Use a torch or grinder to remove the upper coil bucket and factory trailing arm mount. Grind the rivets down to the frame and use a punch and hammer to knock the punches out.
4. Install the sway bar drop brackets (part # DS and PS). Use the factory bolts that go into the frame. It will be required to weld the outside tabs to the side of the frame. Make sure the brackets are straight up and down.

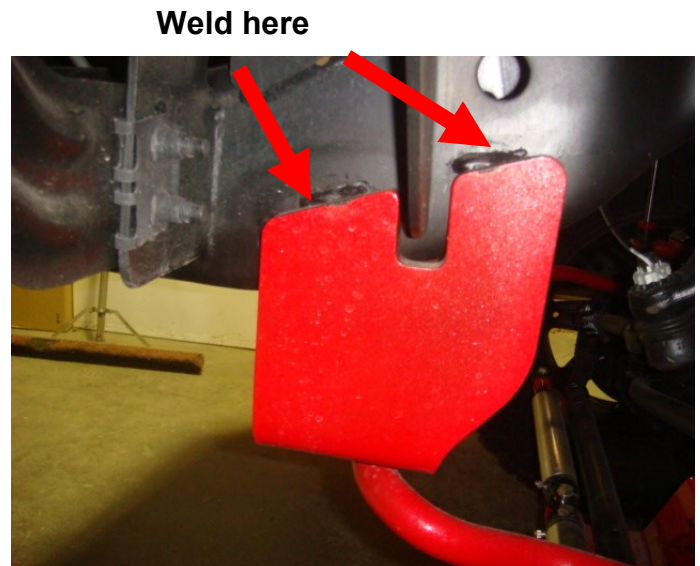
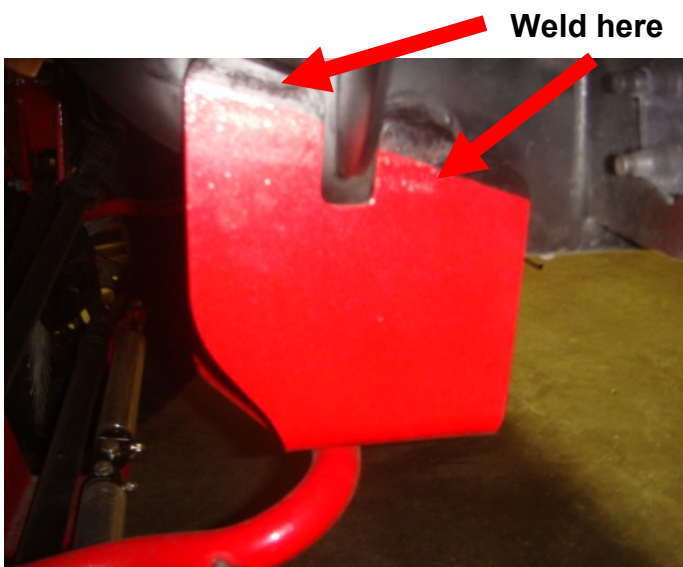



NOTE: When welding on a vehicle either disconnect the batteries or use a battery saver / anti-zapper to prevent damage to the electronics.



5. Remove the factory pitman arm and install the dropped pitman arm (FA 450). Torque to 275 lb/ft. Reconnect the steering arm and make sure to reinstall the cotter pin and nut cover. **NOTE: You will need to re-torque the pitman arm at 400 miles. This requires the pan hard bar drop bracket to be removed.**

Panhead bolt goes closest to air bag. Insert all bolts facing upwards

6. Install the pan hard bar drop bracket (part # 16427). Use the 1/2 x 1 1/2" smooth allen bolt to fasten the rear hole (closest to air bag) of top of the Panhard bar drop bracket to the frame. Re-use the factory bolt in the forward hole of the panhard bar drop bracket. Do not tighten yet. Next, locate the backing plate. You will need to grind on the front side of the factory engine cross member lip to get the backing plate to sit flush with the three supplied spacers. Use three 1/2x2" bolts on the backing plate and ph bar bracket and three 1/2x3" bolts for the backing plate, spacers, that fasten to the engine cross member. Leave all the bolts loose and tighten after they are all started. Use the 20mm bolt to fasten the factory pan hard bar to the drop bracket. Torque the 1" bolts to 85 ft/lbs. Torque the 20mm to 150ft/lbs.

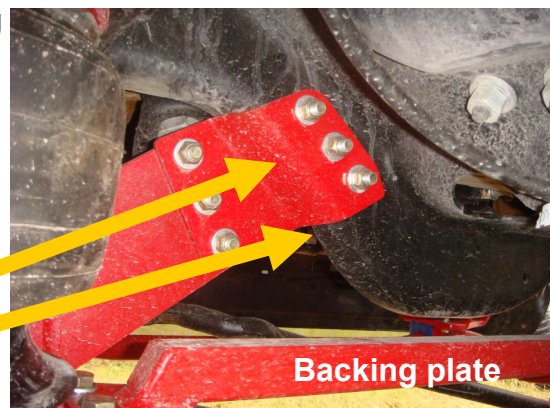
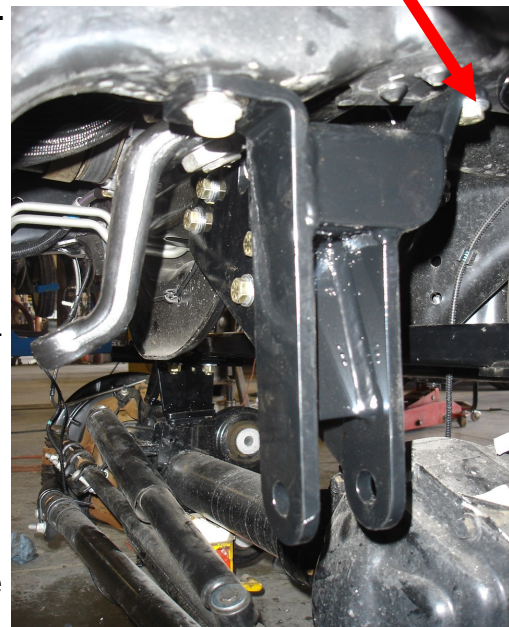

Backing plate

Grind here

Backing plate

7.) Locate the upper air bag brackets (part #10000 PS and #10482 DS) It will be required to drill out the four 3/8" holes in the frame out to 1/2". Once you drill out the holes, use the four 1/2" x 1 1/2" bolts to fasten the bracket in place. Torque the 1/2" bolts to 85 ft/lbs.

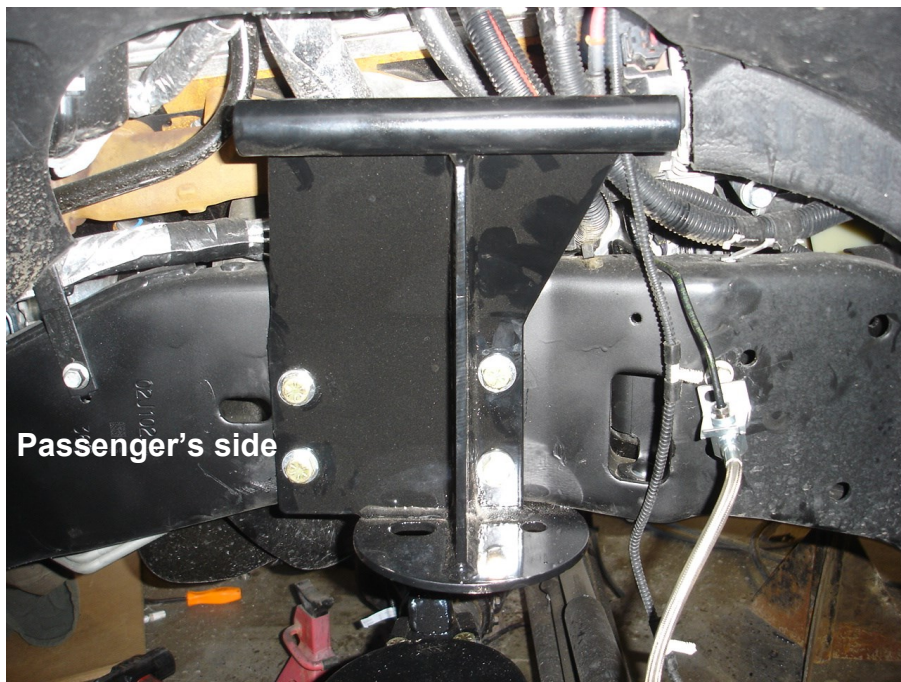
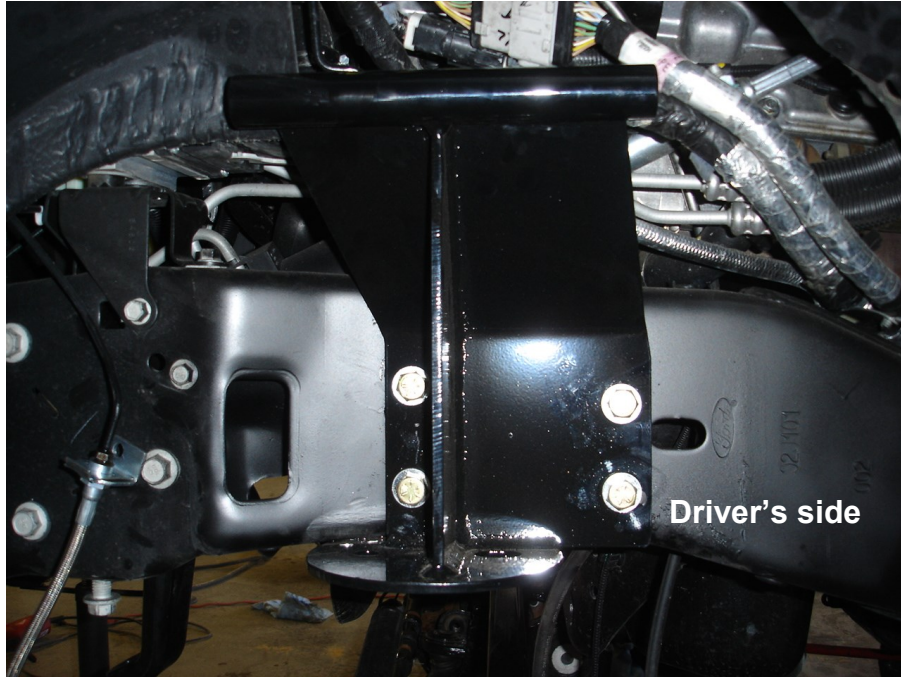

8.) Locate the lower driver's side lower air bag bracket (part #DS). Set in place and mark the hole on the of the axle casting where the factory rubber bump stop would normally come into contact with.

Remove the bracket and drill a 1/2" hole in the center of the marked hole. (or you can tap it for the 7/16"x20 bolt) Next, locate the passengers side lower air bag bracket (part #11120 PS) and position it on the axle. You will have to drill another hole in the axle just as you did on the drivers side (large enough for the 7/16" bolt). You will set the bracket in place and mark the axle in the center of the two plates on top of the axle. Next, start the 14mm bolts (do not tighten) that hold the lower air bag mount to the axle. Install the 7/16" bolts in the holes you drilled/tapped (do not tighten).

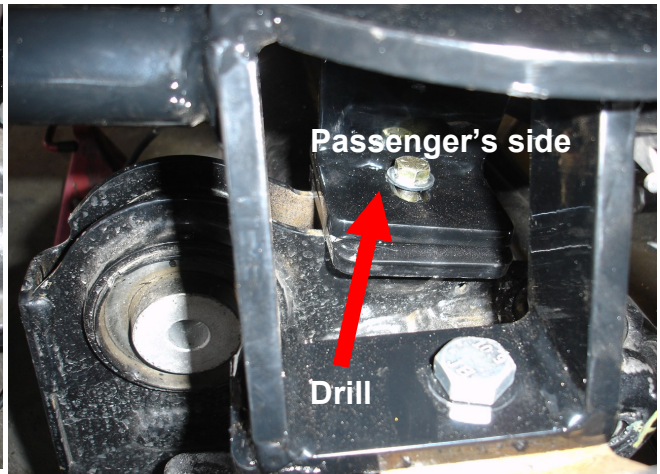
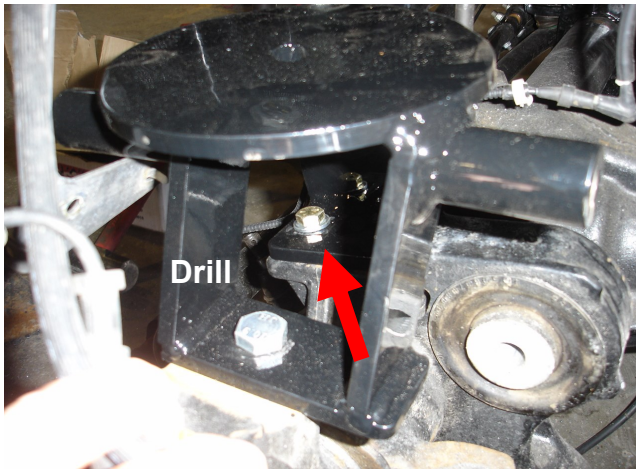

9.) Locate the 32 1/4" cross member, (part # 10565) Next, start the 2"x1 1/2" bolts in the holes to fasten the cross member to the tabs on the lower bag mounts. Once all the bolts are started, go ahead and tighten starting with the 14mm and 7/16" bolts lower bag mounts. Torque the 7/16" bolts to 65 ft/lbs and the 14 mm bolts to 85 ft/lbs, and 1/2" bolts to 85 ft/lbs.

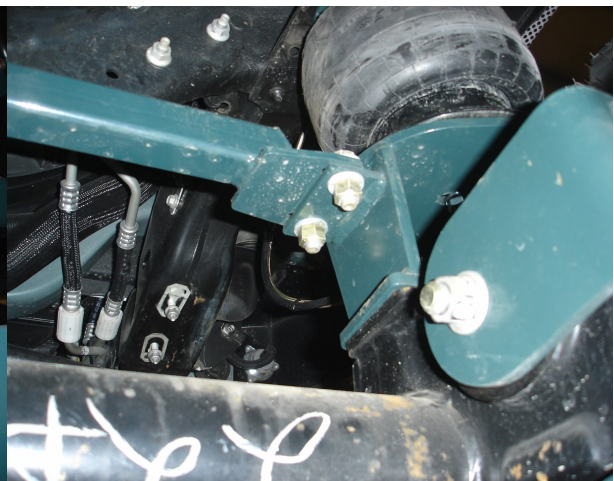

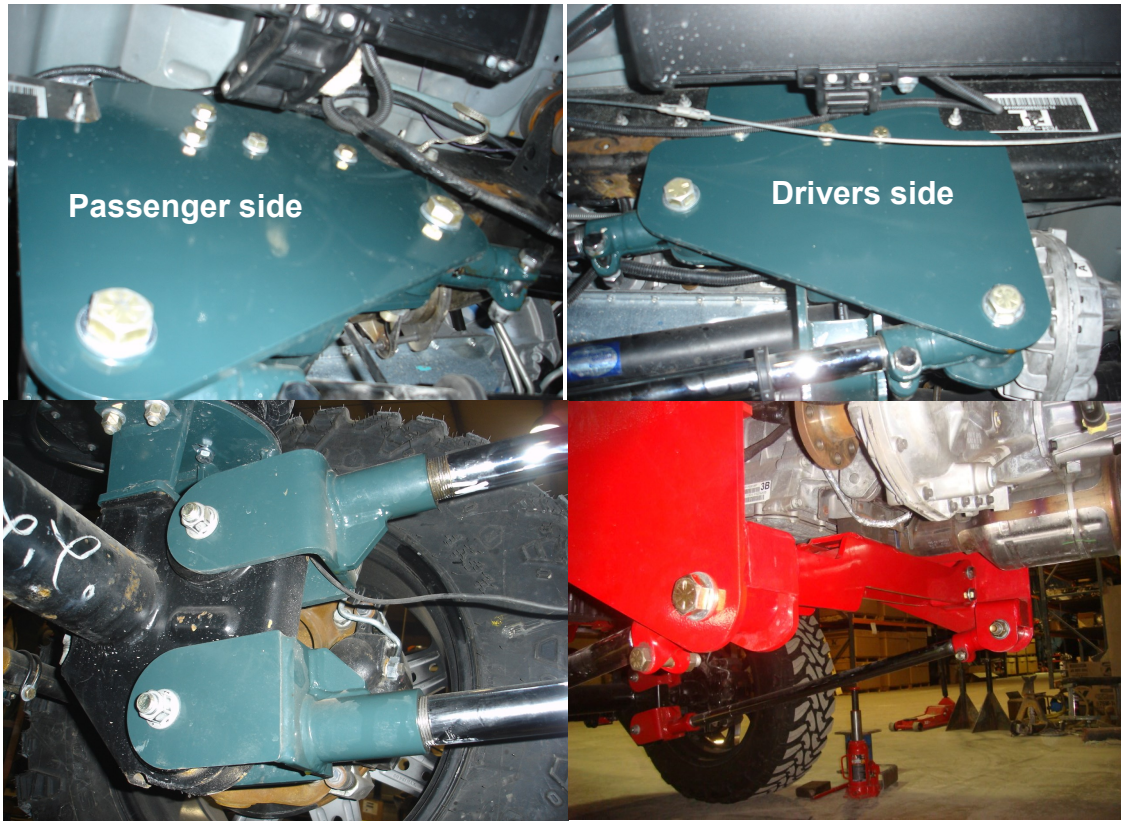

10.) Place a jack under the transmission / transfer case and remove the factory transmission cross member. Locate the trailing arm side plates (part # DS & #PS) and fasten them to the frame using the 1/2" x 1 1/2" bolts.

11.) You will have to drill two 1/2" holes in the side of the frame and enlarge the 2 holes in the bottom of the frame. Fasten the bracket to the frame and use a center punch to mark the location. Remove the bracket and drill the holes. Put the bracket back on, install the bolts, but do not tighten yet.

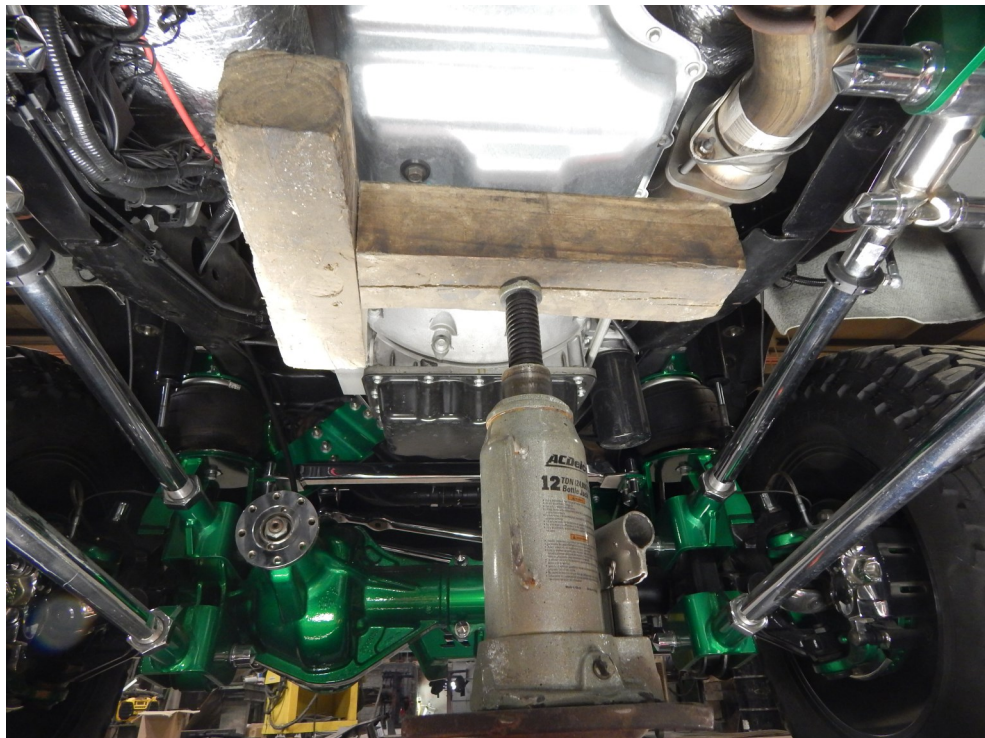

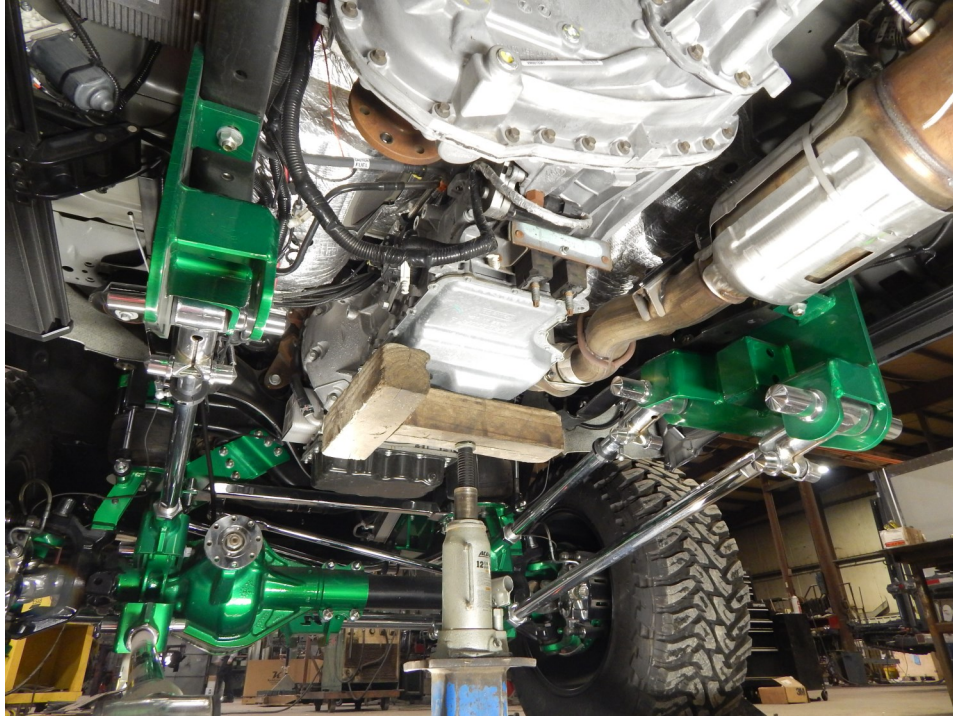

12.) Remove the mounting bracket off the bottom of the transfer case. Keep the 2 bolts as they will be used again.



13.) Remove the rear driveshaft. Remove the 2 nuts off the transfer case mounting bracket.

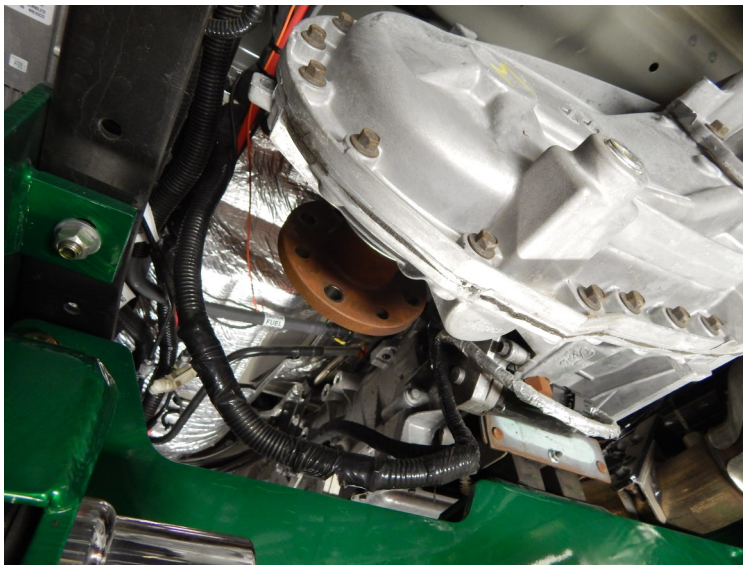
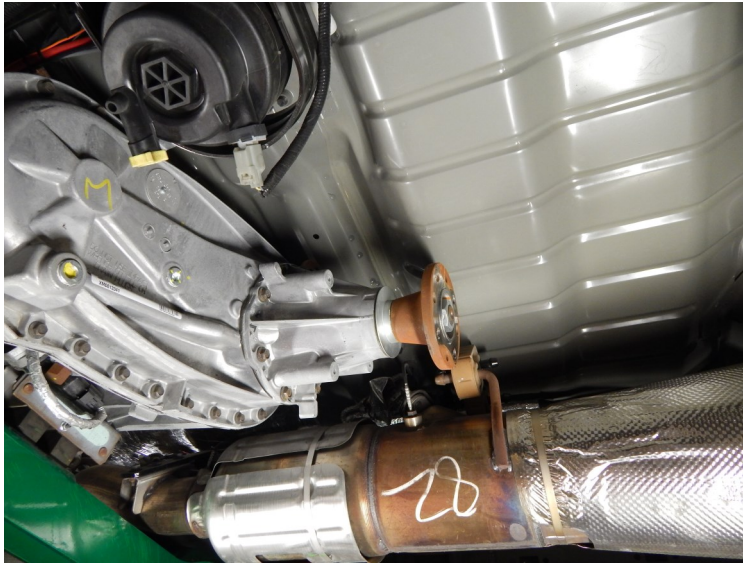

14.) Unhook and remove the wiring harness from the transfer case. Also reach on top and unhook the vent hose. Now remove the 11 bolts that hold the transfer case to the transmission. Once these bolts are removed slide the transfer case off. Its heavy so don't try and do it by yourself.

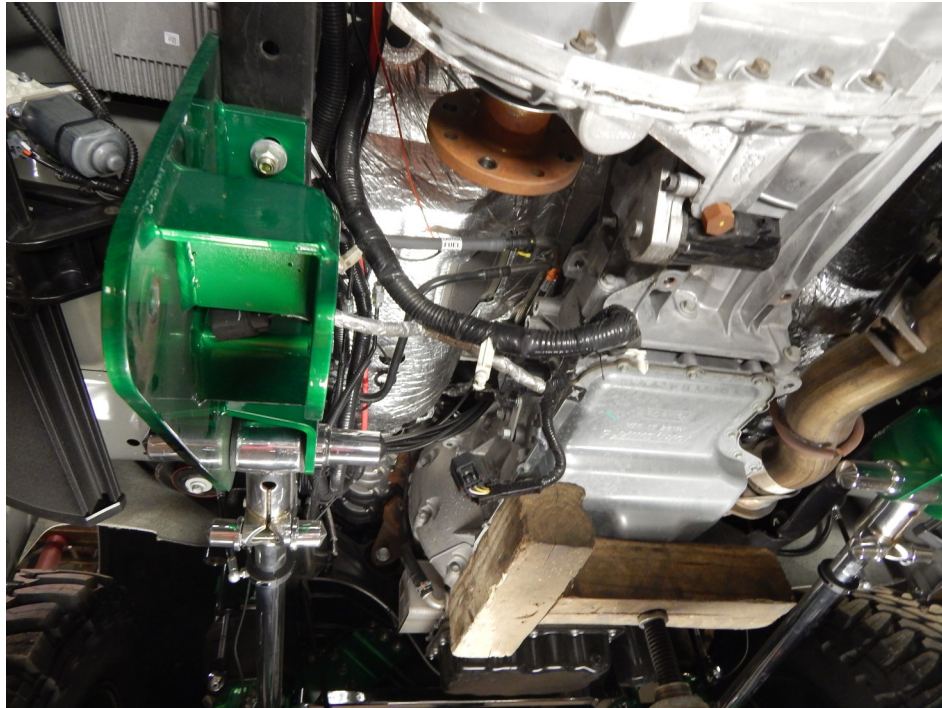

15.) Now that the transfer case is removed locate the indexing plate. Fasten it to the transmission with the eleven M10x30 socket head cap screws. NOTE: USE RED LOCTITE. IF YOU DON'T HAVE LOCTITE DO NOT PROCEED UNTIL SOME IS ACQUIRED. Torque these to 35 ft/lbs.



16.) Locate the 11 m10x40 bolts. Install with the lock washer and apply LOCTITE as you did on the bolts before. Torque these bolts to 35 ft/lbs also.

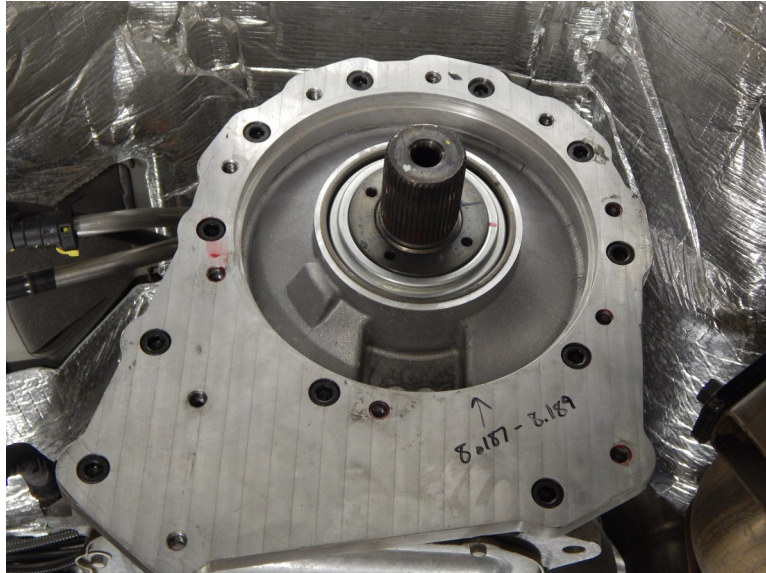

17.) Reinstall the drive shafts. Torque the front and rear drive shaft bolts to 55 ft/lbs (m12)

18.) Locate the upper trailing arms (part #11107) and lower trailing arms (part #11108) Set the top bars so the measurement between the jam nut and the knuckle is 22 1/4" Adjust the top bar to 26" between the jam nut and knuckle. This will get you close to the correct pinion angle and centering of the axle in the fender well. **MAKE SURE THE FRONT KNUCKLES ARE SPREAD APART.** Use the 7/8" x 5 1/2" bolts with flat washers on the rear and use the 18mm x 5 1/4" bolt on the front. Use the factory nuts with the 18mm bolts. Do not torque the trailing arm bolts until the bags are installed and at ride height.

19.) Locate the transfer case mounting “wedge”. It fastens to the bottom of the transfer case with the bolts you removed earlier. Now fasten the OEM transfer case mount to the bottom of the wedge. Use the supplied 1/2x1 1/2” bolts. Torque these bolts to 85 ft/ lbs.

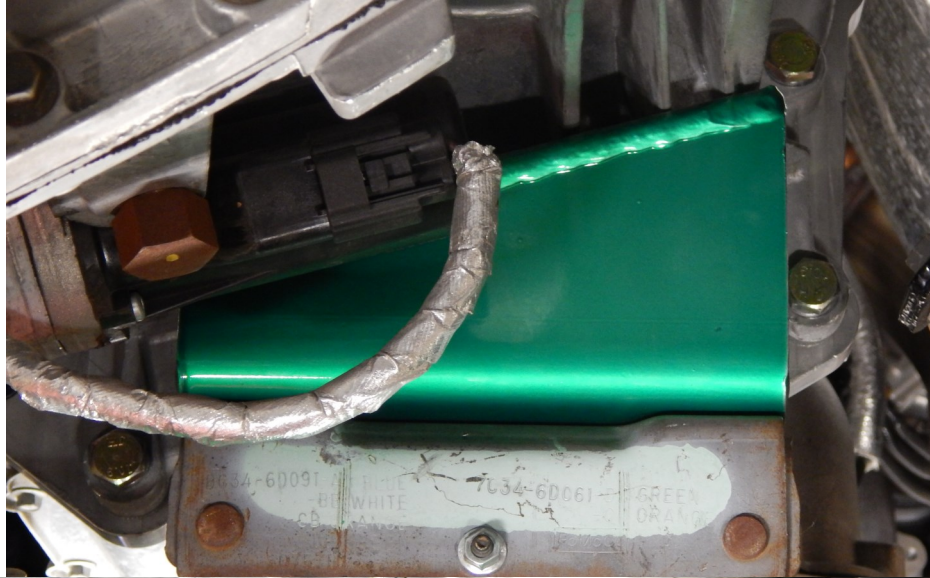

20.) Locate the 5323 air bags. Install in place using the 1/2" x 3 1/2" bolt, flat washer and lock washer in the bottom of the bag. Use the 1/2" and 3/4" nuts and 3/4" lock washers for the top of the bags.

21.) Locate the front sway bar. Fasten to the bottom of the sway bar drop brackets using the blue poly bushings and the gold clamps and 3/8" x 1 1/2" bolts. Hook up the factory sway bar end links to the sway bar.

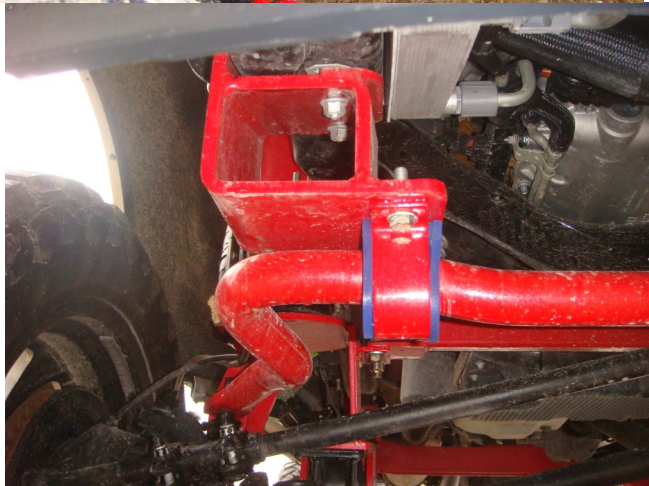
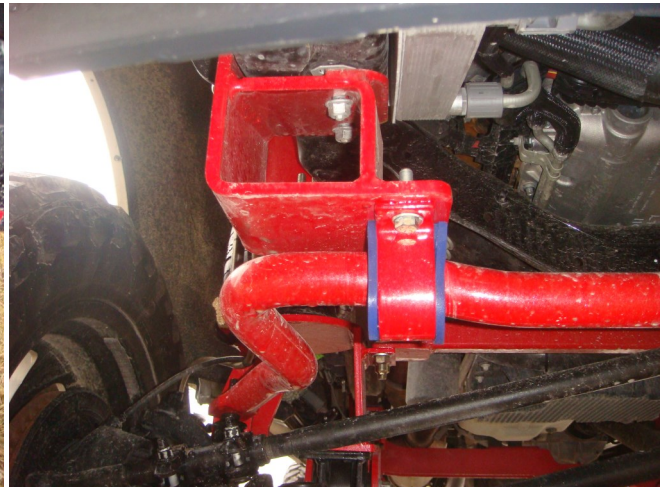

22.) Locate the brake line extensions. Install and bleed the brake lines.

23.) Alignment: This can be done by manually filling the air bags or using the air control system if installed. Begin by inflating the air bags to 8" tall. This measurement should be taken between the mounting brackets that hold the bags in place. Once the bags are at the correct height, put a pair of jack stands under the frame by the radiator and let the air out of the bags. Locate the angle finder and use it to adjust the pinion angle back to the factory setting. This will put the caster and camber back to the factory setting.

24.) Adjust the axle until it is centered in the wheel well and squared up with the rear axle. At ride height, the bag should be straight up and down. Adjust the axle so it is centered in the wheel well while keeping the pinion angle correct. Once the rear kit has been installed, measure from the front side of the rear axle to the kingpin on the front axle. Make sure the measurement is within 1/8".

25.) Shock installation. Once the front axle is aligned and at the proper ride height, locate the front shocks. Use the 1/2" x 2" bolts to install the shocks. Use the supplied spacers with the shocks. Once the shocks are installed and the truck is at ride height, 8" bags, they should be straight up and down.

26.) Locate the steering stabilizer kit. Take out the middle two bolts on the passenger side of the differential cover. Locate part # 16005 and place it on the front side of the axle. Use the bolts that you took out of the diff oover to fasten the right side of the bracket and use four 1/2" x 1 1/2" bolts to fasten it to the backing clamp. Locate the shock end mounts (p/n 16007 DS and #16007 PS) and fasten them to the pinch bolts on the drag link. Next, locate the steering stabilizer shocks and install them with 1/2" x 2" bolts. Make sure there is a spacer on each heim end.



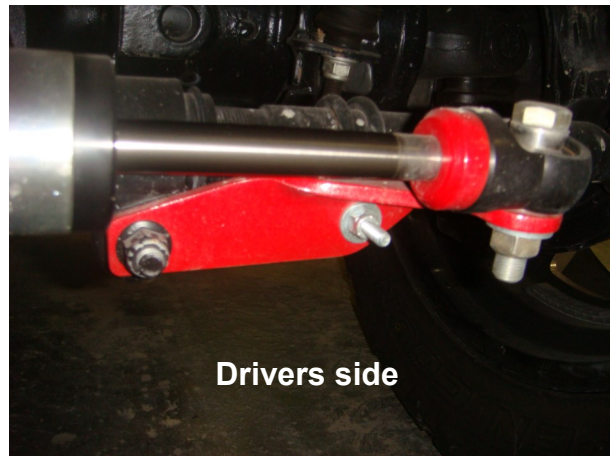
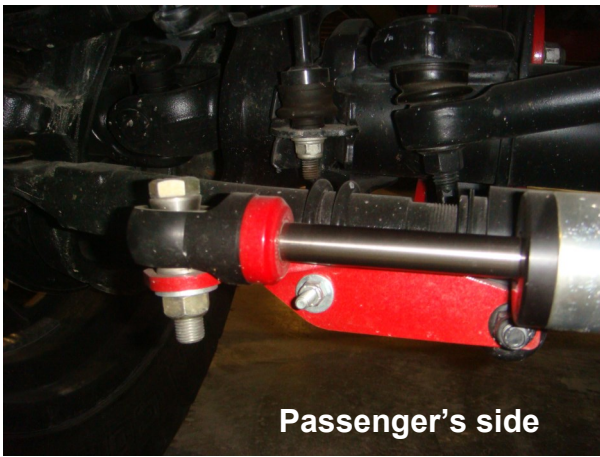

27.) Check bag height and make sure both front bags are set the same. They should be set anywhere from 8-8 1/2" tall.

28.) Use the adjustment on the passengers side bottom part of the steering arm coming off the pitman arm to straighten the steering wheel. Make sure that the tabs and bolts are pointing forward so they don't catch on any suspension parts, causing the steering to lock.

29.) Final torque. Re-check every bolt installed and ensure they are torqued to the provided specifications. Examine the entire kit for any clearance issues before driving the vehicle.

30.) Test drive the vehicle. The truck should drive straight, but the steering will be off. If the truck pulls to the right, the right front needs to be pushed forward. If the truck pulls to the left, the left front needs to be pushed forward. Once the truck drives straight, adjust the steering wheel by turning the adjuster on the factory steering arm until the steering wheel returns to a centered position.

Tuesday, December 16, 2014 12:49:45 PM

ITEM NO.	PART NUMBER	DESCRIPTION	No Frame/Qty.
1	10000	(PS) Bag Mount / Duel Shock	1
2	10565	Crossmember - 31" Center to Center	1
3	11107	TRAILING ARM - 28.50	2
4	11108	43" Trailing Arm	2
5	16442	(PS) Sway Bar Drop Bracket	1
6	16443	(DS) Sway Bar Drop Bracket	1
7	18086	Transfer Case Crossmember 25°	1
8	18091	25° Mounting Bracket	1
9	20127	(DS) Lower Bag Mount	1
10	20131	(PS) Front Side Plate	1
11	20132	(DS) Front Side Plate	1
12	20158	(DS) Bag Mount / Duel Shock	1
13	20160	(PS) Lower Bag Mount	1
14	30551	Panhard Bar Drop Bracket	1
15	16429	Steering Stabilizer F250/350 Assembly	1
16	5323-1	Firestone 5323	2

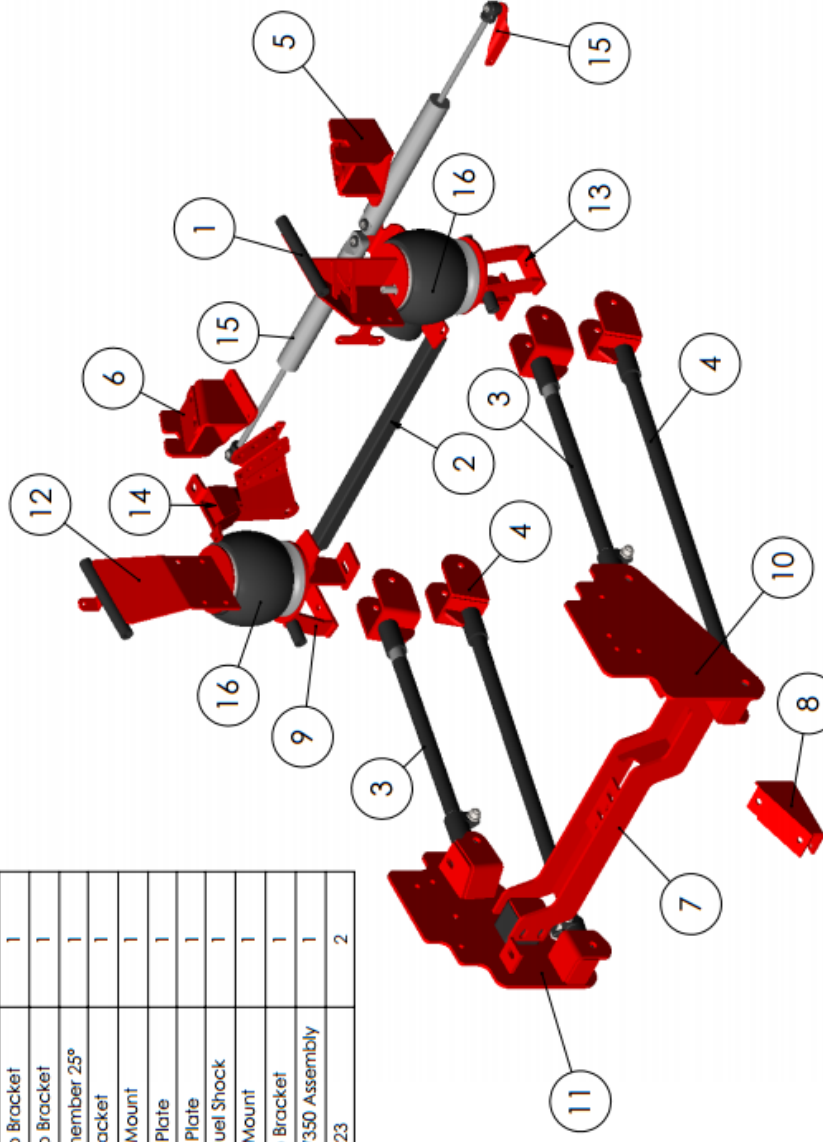

UNLESS OTHERWISE SPECIFIED:		Project: 2011 Ford F250/350	
DIMENSIONS ARE IN INCHES TOLERANCES:	FRACTIONAL 1/32"	Design By: Zach Beltz 2014	Shell # / Qty
ANGULAR: MACH 1 BEND 1	TWO PLACE DECIMAL .030	Inventory	Run Qty:
THREE PLACE DECIMAL .010	MATERIAL	Description: 8-10" Front Lift	
FINISH	PROPRIETARY AND CONFIDENTIAL		
	THE INFORMATION CONTAINED IN THIS DRAWING IS THE SOLE PROPERTY OF KELLERMAN MFG. INC. ANY		
	SIZE DWG. NO.	A F4F4-23-X-11-10	

